

Dual-line automatic lubrication systems

Product catalogue 2023

INCL.
BARREL
PUMP BPH,
METERING DEVICE
SMG AND THE
WAY VALVES
E-VALV-S/L

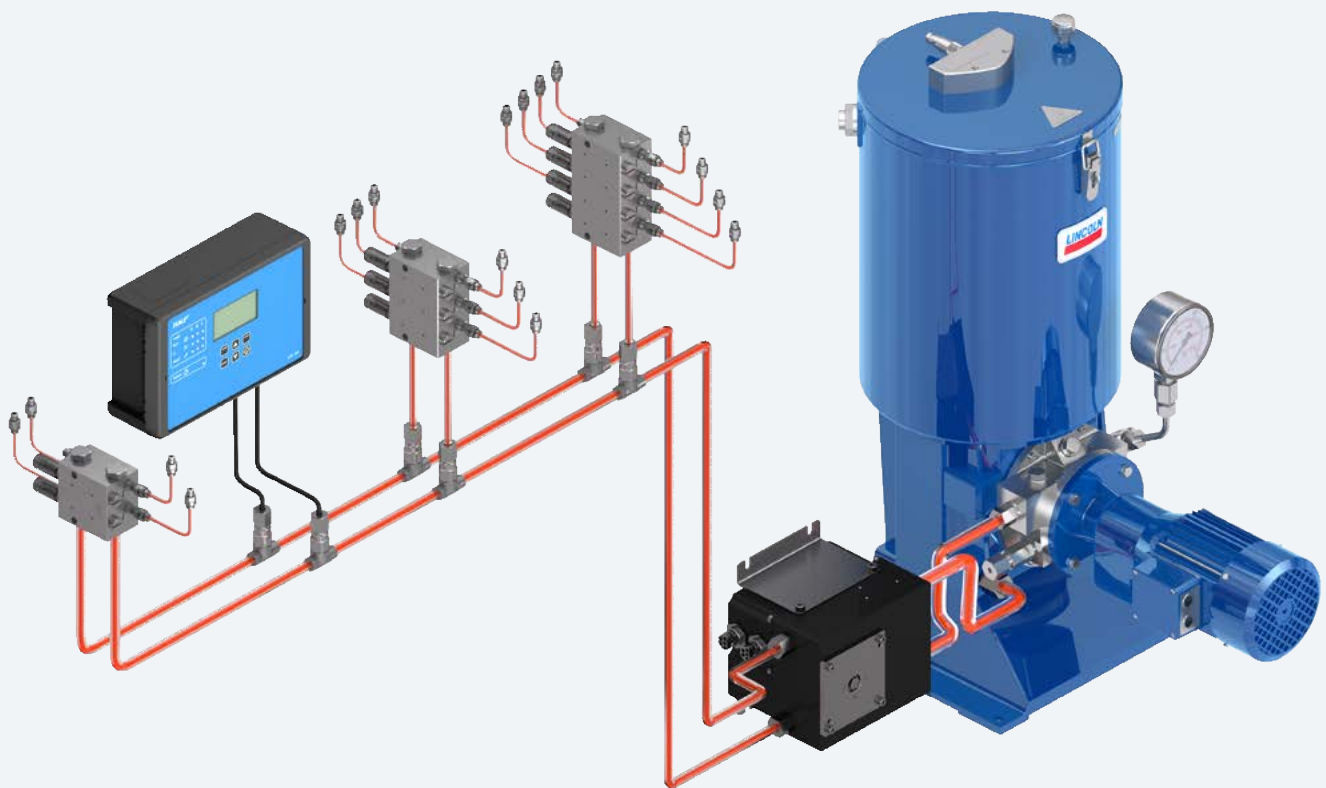

Table of content

Electronic part library	4	Overview of valves	51
Lubricants suitable for lubrication systems	5	DU 1	52
System description	6	MP 2	53
Applications	7	E-VALV	54
Overview of pump units	9	Maxilube	56
HJ 2	10	EMU 3	58
Multilube	12	DVA Dualset valve assembly	59
ZPU 01/02	14	CLV-2	60
FK	16	E-VALV-S	62
ZPU 08/14/24	18	WSE	64
E-PUMP	20	Overview of pressure sensors	67
MPB	22	DSB 1	68
Lubrigun	24	EDW	70
PowerMaster III	26	DW	71
BPH	28	BPSG PTA-MOD	72
Overview of metering devices	31	DDS 50/1	73
SMG	32	DPC 1	74
VSKH/VSKV	34	Overview of control units	77
VSG	38	LMC 2	78
VSL	42	LMC 301	79
SGA/SG	46	ST-1240	80
		ST-2240-LUB	81
		Index	82

Navigation

Introduction	2
Pumps units	9
Metering devices	31
Valves	51
Pressure sensors	67
Control units.	77

Electronic part library

CAD product data

Introduction

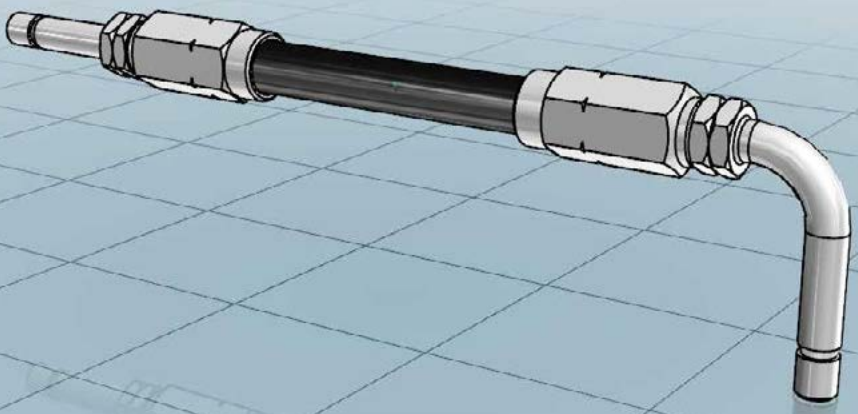

Find your parts online

3D CAD data, technical drawings and data sheets of SKF automatic lubrication system components are now available in native format in the online parts library. In addition to enjoying easy CAD downloads, you can configure more complex lubrication system products and integrate them into your design process – completely free of charge. Integrate CAD data seamlessly into your layout plans without any delay.



<https://skf-lubrication.partcommunity.com>

Lubricants suitable for lubrication systems

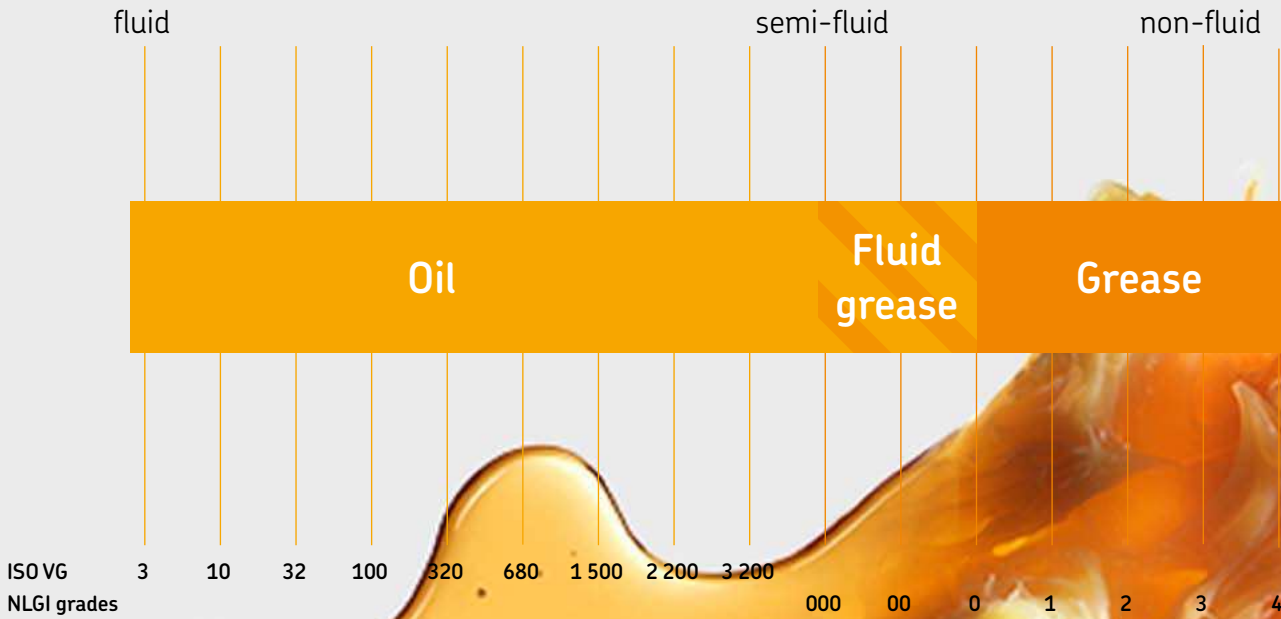

Oil and fluid grease

The viscosity is an expression of a fluid's internal friction. Oils are classified in ISO VG viscosity classes from 2 to 3 200. NLGI grade 000, 00 and 0 greases are called fluid greases. Different types of oils are available, including mineral oils, organic oils and synthetic oils. A compatibility check is recommended prior to using any oil with SKF lubrication systems.



Grease

Greases are consistent lubricants (NLGI grade 1–6). They are soft to hard, triple-component mixtures of a base oil as the lubricating fluid, a thickening agent and additives. In most instances, greases of NLGI grade 1 up to 3 are suitable for use in a lubrication system. A compatibility check should be made prior to using any grease with SKF lubrication systems.



System video

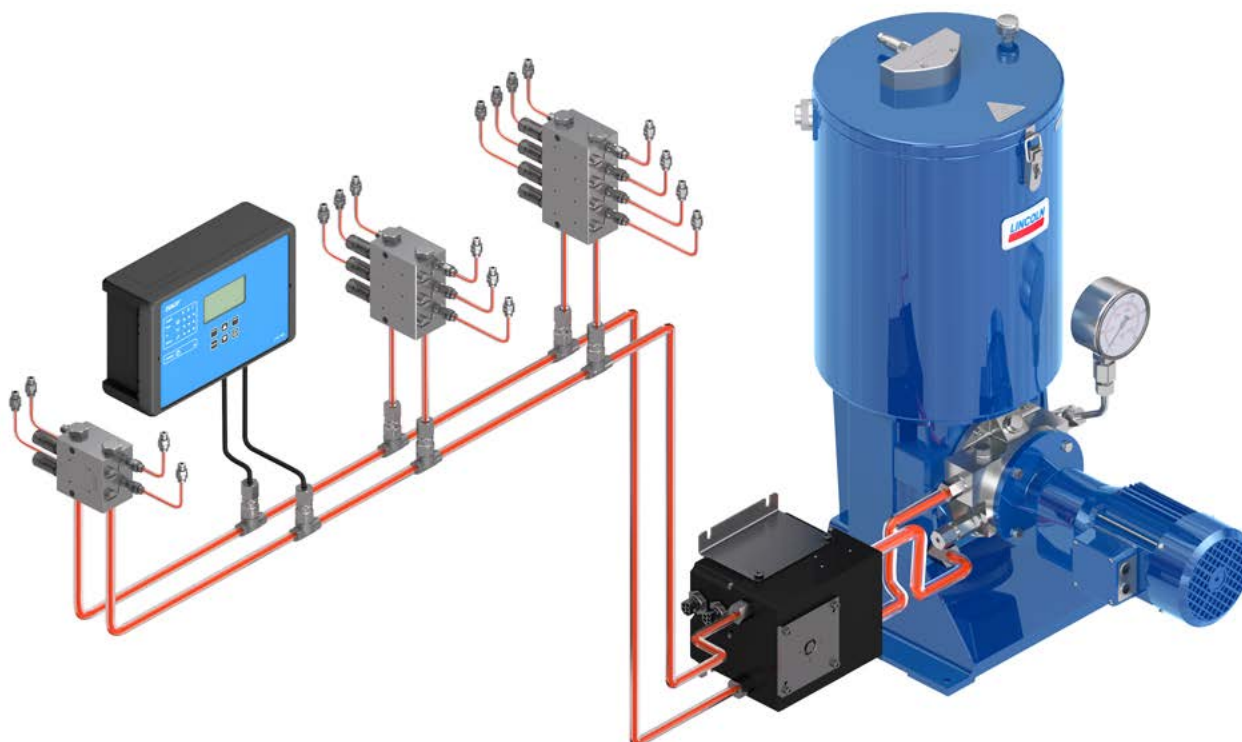

System description

SKF dual-line systems can be used on large systems with dispersed lubrication points that require varying lubrication quantities. These systems utilize two main lines that are supplied alternately with lubricant from a high-pressure pump via a change-over valve at up to 400 bar (5 800 psi). Branch lines, along the main lines, are connected with dual-line metering devices to supply a large volume of lubricant to the lubrication points. Within large dual-line systems, end-of-line pressure switches are used to control and monitor the system. These flexible systems are simple to design and can be extended or reduced easily by installing additional metering devices or by removing them. A redesign of the system is not required. Dual-line metering devices can be combined with downstream progressive metering devices to increase the total number of lubrication points receiving small lubricant amounts. SKF offers dual-line systems that can dispense a precise, metered amount of lubricant to up to 2 000 lubrication points over long distances up to 120 m (131 yd) and more, depending on case values.

Even if one pair of outlets becomes blocked inside one metering device, SKF dual-line systems provide sufficient lubrication for the rest of the system's lubrication points. Lubricant volume can be metered individually for each pair of outlets and can be monitored visually or electrically.

The function principle of the dual-line systems consists of two half-cycles. In the first half-cycle, the lubricant is pumped into the main line (A) and the main line (B) is connected to the relief line. The lubricant, which is conducted by the change-over valve, is supplied to the metering devices. The pistons of the metering devices are moved into their adjusted end positions, thus dispensing an exact, metered quantity of grease. Once all metering devices have dispensed their lubricant to the consumption point, the system is hydraulically closed, which causes the pressure in main line (A) to rise until the preset pressure at the end-of-line pressure switch (mounted in the main lines prior the last metering device) is reached. This pressure switch then signals an electric pulse to the control unit, which turns the pump off and signals the change-over valve to relieve main line (A), and the pause time starts. At this stage, half of the lubrication points in the system have been lubricated.

In the second half-cycle, main line (B) is pressurized and the cycle continues as before.

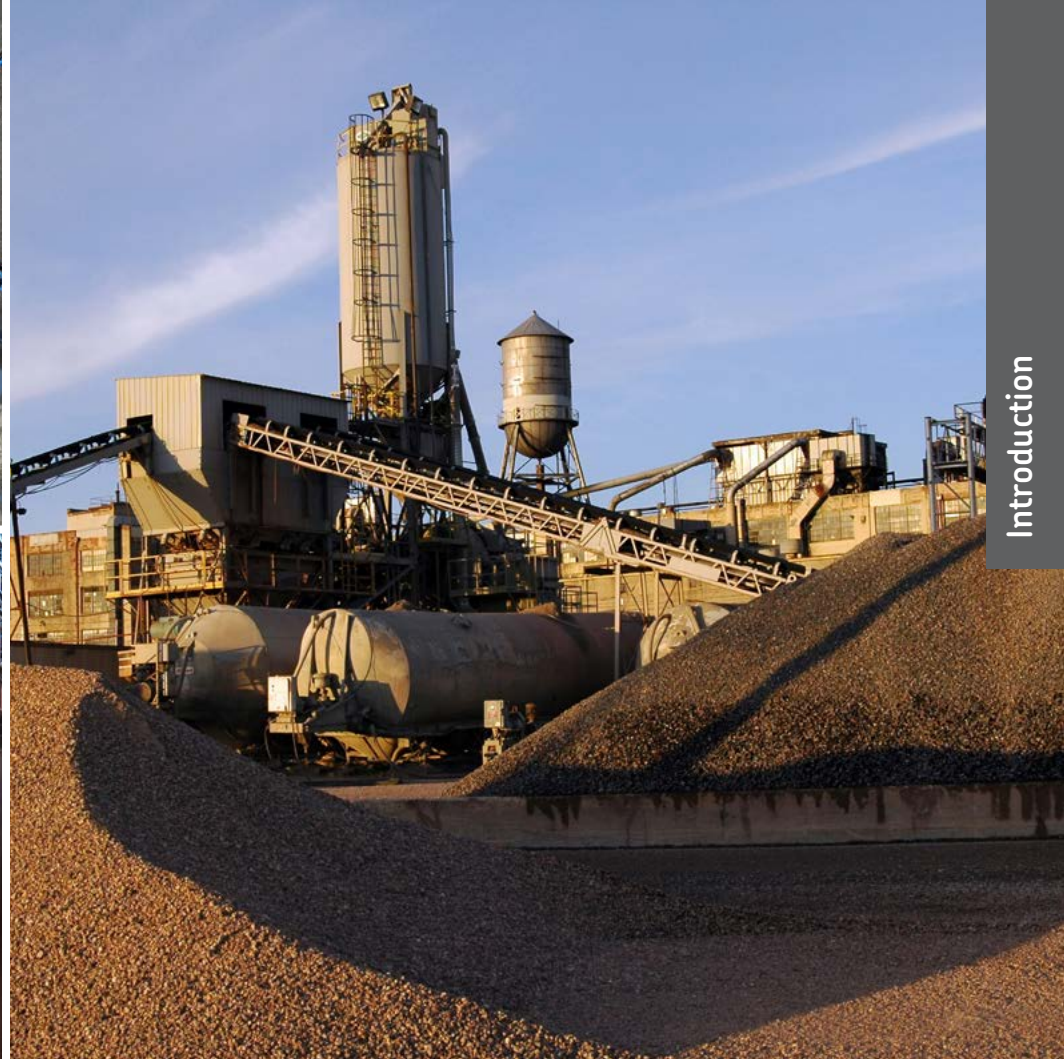

Applications

SKF dual-line lubrication systems are developed for use with oil, semi-fluid grease and hard grease up to NLGI grade 2. Harder greases of NLGI grade 3 only can be used if so determined after consultation. SKF dual-line lubrication systems are suitable for a variety of applications, including heavy industry, metal working plants, pulp and paper production, mining, mineral processing, power plants, cement factories, steel works and more. These reliable systems operate effectively in the harsh conditions associated with these industries, including potentially high lubrication-point back pressure, dirty, wet or humid environments and low temperatures.



Overview of pump units

Manually operated pumps

Product	Lubricant class	Function principle	Metering quantity max.		Reservoir		Operation pressure max.		Page
			cm ³ /stroke	in ³ /stroke	l	gal	bar	psi	
	NLGI								
HJ 2	up to 3	Piston pump	1-2	0.06-0.12	3	0.79	300	4 350	10

Electrically operated pumps

Product	Lubricant class	Function principle	Metering quantity max.		Reservoir		Operation pressure max.		Page
			cm ³ /h	in ³ /h	l	gal	bar	psi	
	NLGI								
Multitube	up to 2	Piston pump	960	58.5	4-10	1.05-2.65	220	2 900	12
ZPU 01/02	up to 2, 3 on request	Piston pump	800-1 600	49-97.5	10-30	2.6-8	400	5 800	14
FK	up to 3	Piston pump	740-4 440	45-270	15-60	4-16	400	5 800	16
ZPU 08/14/24	up to 2, 3 on request	Piston pump	8 000-24 000	490-1 465	40-100	10-26	400	5 800	18
					Applicable barrel sizes				
			cm ³ /h	in ³ /h	kg	lb	bar	psi	
E-PUMP	up to 2	Barrel pump unit	3 300	1 299	18, 50, 180	40; 120; 400	300	4 350	20

Air - operated pumps

Product	Lubricant class	Function principle	Metering quantity ¹⁾ max.		Applicable barrel sizes		Operation pressure max.		Page
			cm ³ /stroke	in ³ /stroke	l	gal	bar	psi	
	NLGI								
MPB	1 + 2	Piston pump for barrels	6,1	0.37	18, 50, 180	40, 120, 400	300	4 350	22
Lubrigun	1 + 2	Piston pump for barrels	5,7	0.35	50, 180	120, 400	515	7 500	24
PowerMaster III	1 + 2	Piston pump for barrels	34-60,5	2.1-3.7	50, 180	120, 400	515	7 500	26

¹⁾ Total metering quantity per time depends on air pressure, counter pressure, grease properties and ambient temperature

Hydraulically operated pumps

Product	Lubricant class	Function principle	Metering quantity max.		For reservoir size	Operation pressure max.		Page	
			cm ³ /stroke	in ³ /stroke		l	gal		bar
	NLGI								
BPH	up to 2	Barrel pump unit	30	1.83	208	55	120	1 740	28

Pump unit

HJ 2



Description

The manually operated HJ 2 pump unit was developed to provide lubricant to points that do not require continuous lubrication. Comprised of two supply pistons and a 3 liter (0.8 gal) reservoir with an integrated stirring device, this robust pump unit operates effectively, even at low temperatures. Operating pressure is 300 bar (4 350 psi).

Features and benefits

- Suitable for use with dual-line or progressive systems
- Dispenses greases up to NLGI 3
- Available with left- or right-hand lever

Applications

- Metal forming machines
- Roll straighteners
- Tyre heating presses
- Harbor cranes
- Ski lifts

Technical data

Function principle	manually operated pump unit
Outlets	1
Lubricant output per stroke	1–2 cm ³ , 0.06–0.12 in ³
Lubricant	grease: up to NLGI 3, depending on operating temperature oil: with a viscosity minimum 150 mm ² /s at operating temperature
Operating temperature	–20 to +70 °C, –4 to +160 °F
Operating pressure	max. 300 bar, 4 350 psi
Hand force at max. pressure	300 N
Reservoir capacity	3 l, 0.8 gal
Outlet connection	G 1/4
Dimensions	410 × 135 × 393 mm 16.1 × 5.5 × 15.5 in
Mounting position	vertical



NOTE

Further technical information, technical drawings, accessories, spare parts or product function descriptions are available on SKF.com/lubrication.

Pump unit

HJ 2

Order information

Order number	Designation	Position hand lever	Outlet
603-41200-2	HJ 2 L-3 XYN	left	1
603-41200-1	HJ 2 R-3 XYN	right	1

Note: for two outlet versions refer to progressive catalogue

Check valves

Order number	Designation	Tube Ø
		mm
223-13052-1	GERV 6-S G 1/4 AVCF	6
223-13052-2	GERV 8-L G 1/4 AVCF	8
223-13052-3	GERV 10-L G 1/4 AVCF	10

Note: must be ordered with pump

223-13052-1



223-13052-2



Pump unit

Multilube



Description

The Multilube pumping unit is especially designed for heavy machines and equipments. It has a very compact size, but still includes all key components and functions required for a lubrication pumping unit as control unit, pump, reservoir, directional valve and pressure monitor. The Multilube pumping unit is compatible with all oil and grease metering devices used in SKF single-line, dual-line and progressive lubrication systems. As one of the built-in features there is a heating device which enables also an operation in extremely cold and demanding environments. Depending on application requirements, auxiliary equipment, such as sliding surface nozzles and lubrication brushes, can be used.

Features and benefits

- Durable, compact structure featuring modular design for simple installation and start up
- Two reservoir sizes available including overfill relief valve and electric low-level switch
- Double ball pumping element for operational reliability
- Filling connection equipped with filter
- External pressure relief valve
- Optional internal or external control
- Suitable for oil and grease systems

Applications

- Paper and heavy industry
- Cranes and stackers
- Reclaimers

Technical data

Function principle	electrically operated piston pump
Operating temperature	-30 to +60 °C, -22 to +140 °F
Operating pressure	max. 200 bar, 2 900 psi
Lubricant	grease: up to NLGI 2 oil: operating viscosity > 46 mm ² /s approx. 960 cm ³ /h, 58.6 in ³ /h
Metering quantity	G 1/4
Outlet connection	24 V DC; 115, 230 VAC/50 or 60 Hz
Electrical connections	IP 67 (IP 65 with user interface)
Protection class	
Dimensions	depending on the model min. 535 × 274 × 244 mm max. 720 × 274 × 244 mm min. 21.06 × 10.8 × 9.6 in max. 28.35 × 10.8 × 9.6 in
Reservoir capacity	4 and 10 l, 1.05 and 2.65 gal
Mounting position	horizontal and vertical

NOTE

Further technical information, technical drawings, accessories, spare parts or product function descriptions are available on SKF.com/lubrication:

PUB LS/P2 6407/2 EN

Pump unit

Multilube

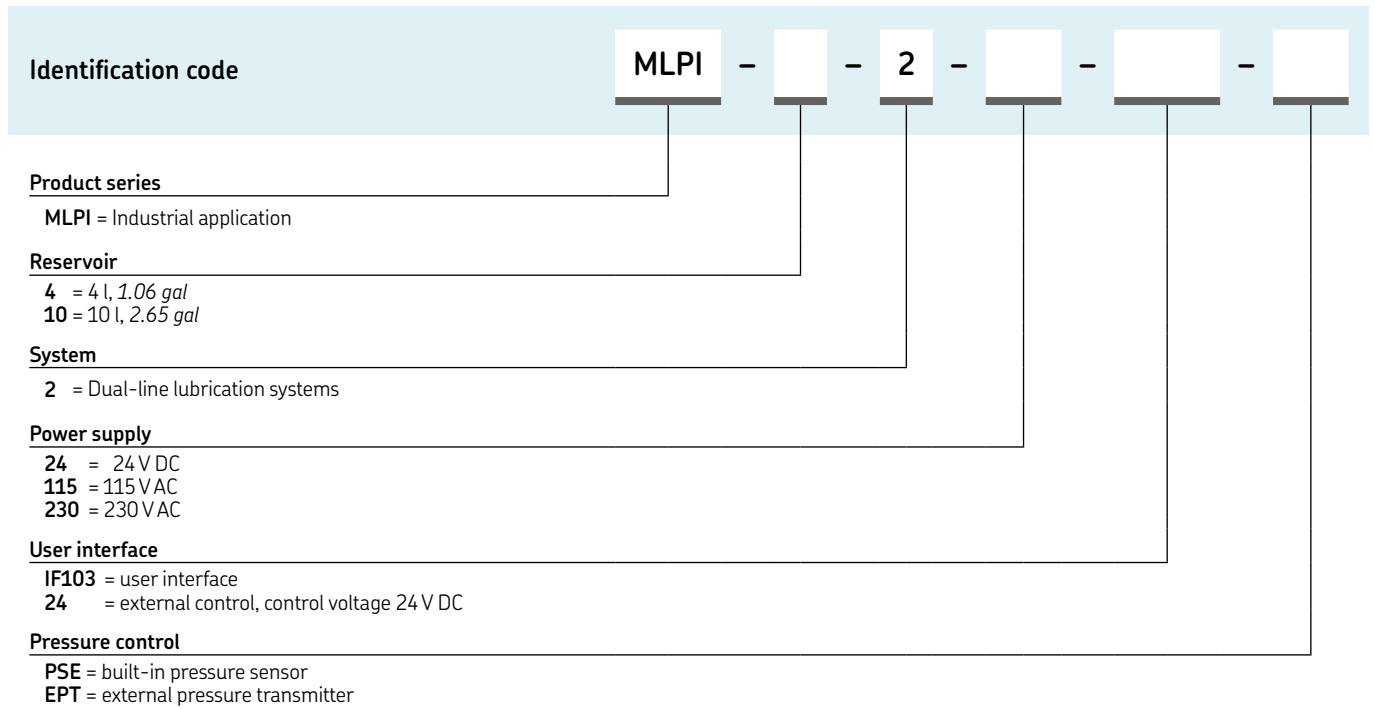

Pump unit

ZPU 01/02



Description

The ZPU 01/02 high-pressure, high-volume pumps can be used as a supply pump unit for small to midsize dual-line systems or for progressive systems. Depending on the system layout, these electric pumps can supply lubricant within a 50 m (54 yd) radius at a maximum pressure of 400 bar (5 800 psi). Available with 10 or 30 l (2.6 or 8 gal) reservoirs, these units are compatible with oil and grease up to NLGI 2 (NLGI 3 upon request). Featuring one or two elements, the ZPU 01/02 pumps work effectively in temperatures ranging from -20 to $+70$ °C (-4 to $+158$ °F) thanks to the integrated stirring device.

Features and benefits

- Reliable
- Versatile
- Ultrasonic low- and high-level control options
- Free shaft end for use with other motors

Applications

- Light to medium industrial applications
- Mixing machines
- Power plants
- Reclaimers
- Stackers

Technical data

Function principle	electrically operated piston pump unit
Operating temperature	-20 to $+70$ °C; -4 to $+158$ °F
Operating pressure	M100, M490: max. 350 bar, 5 075 psi M049: max. 400 bar, 5 800 psi
Lubricant	grease: up to NLGI 2, NLGI 3 on request oil: with a viscosity of min 40 mm ² /s at operating temperature
Metering quantity ¹⁾	ZPU 01: 800 cm ³ /h, 48.8 in ³ /h ZPU 02: 1 600 cm ³ /h, 97.5 in ³ /h ZPU 02-M049: 3 200 cm ³ /h, 195.2 in ³ /h
Reservoir capacity	10 or 30 l, 2.6 or 8 gal
Main line connection ²⁾	model F: for tube 10 mm
Electrical connection	380–420 V AC/50 Hz, 440–480 V AC/60 Hz
Protection class	IP 65
Dimensions	depending on the model: min. 514 × 379 × 317 mm max. 754 × 431 × 337 mm min. 20.25 × 15 × 12.5 in max. 29.75 × 17 × 15 in
Dimensions low level sensor	30 × 125 × 65 mm 1.2 × 5 × 2.75 in
Mounting position	vertical

¹⁾ output increase by 20% for 60 Hz applications

²⁾ for model E and V refer to progressive catalogue

NOTE

Further technical information, technical drawings, accessories, spare parts or product function descriptions are available on SKF.com/lubrication.

Pump unit

ZPU 01/02

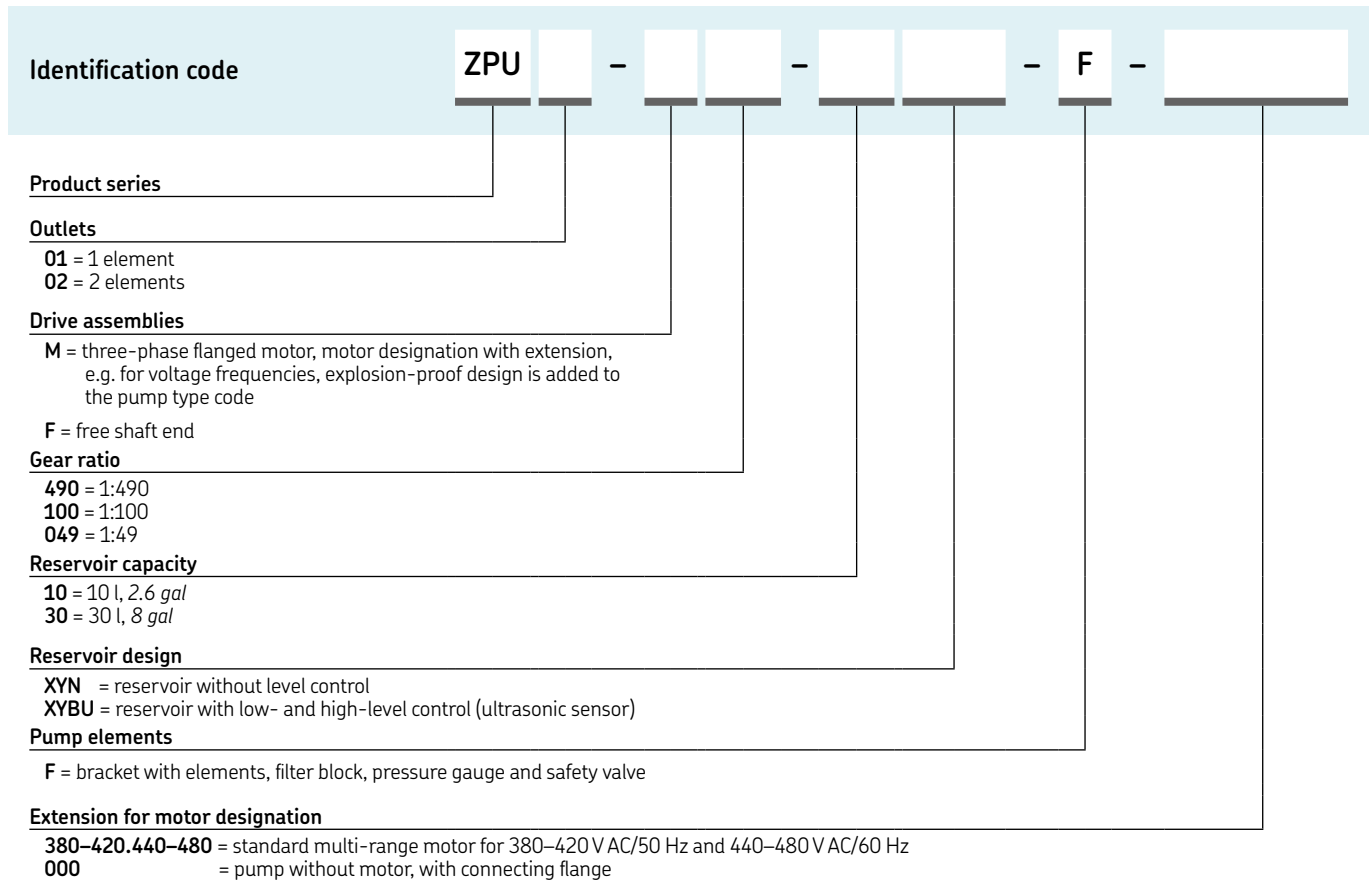

Pump unit

FK

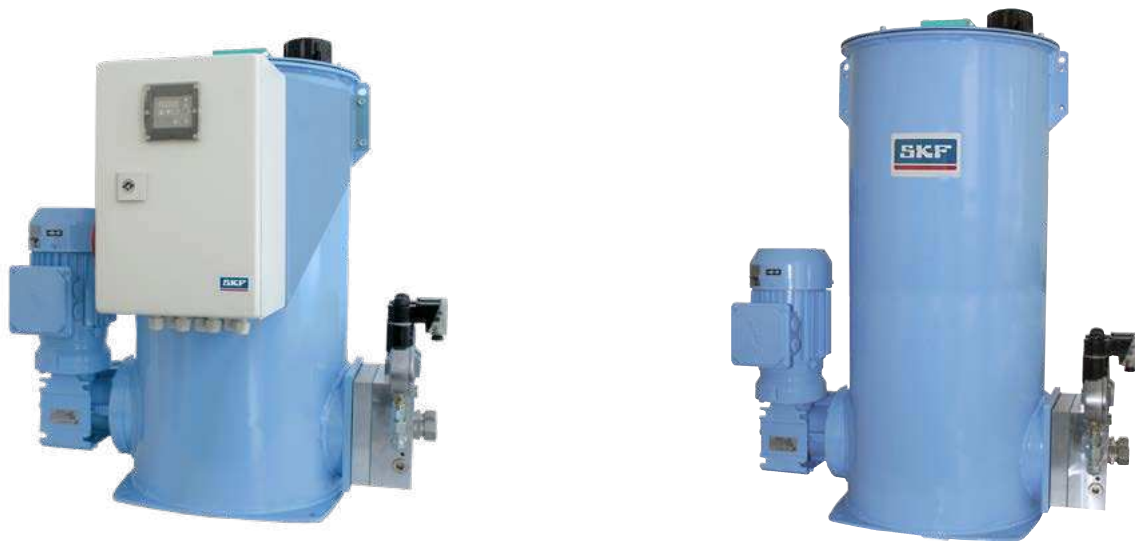

Description

The FK grease lubrication pump unit is suitable for use in small to midsize dual-line lubrication systems. Its compact, modular construction enables it to be retrofitted from one system to another with minimal effort and expense. Depending on the volume of lubricant required, this radial-piston pump unit can be equipped with up to six internal pumping elements and with optional change-over valves.

Available with reservoir sizes of 15, 30 and 60 kg (33, 66 and 132 lb), this robust pump unit has an operating pressure of max. 400 bar (5 800 psi).

Features and benefits

- Positively driven pump pistons for maximum reliability
- Fill level monitoring (using ultrasonic sensors) with two adjustable switching points
- Operates effectively in temperatures ranging from -25 to $+60$ °C (-13 to $+140$ °F)
- Screw conveyor design permits delivery of highly viscous lubricants
- Internal pressure-regulating valve and filter
- Integrated change-over valves optional

Applications

- Crushers
- Heavy equipment
- Rope manufacturing machinery

Technical data

Function principle	radial piston pump unit
Operating temperature	-25 to $+60$ °C; -13 to $+140$ °F with control cabinet: 0 to $+60$ °C; $+32$ to $+140$ °F
Lubricant	grease: NLGI 2 and 3 oil: mineral or environmentally compatible oils from ISO VG 46, operating viscosity ≥ 50 mm ² /s max. 400 bar, max. 5 800 psi
Operating pressure	see order number configurator next page
Metering quantity	15, 30 and 60 l; 4, 8 and 16 gal
Reservoir	G 1/2
Outlet connection	motor: 230/400 V AC, 50 Hz solenoid valves, sensor: 24 V DC
Electrical connection	IP 55, with control cabinet: IP 54 depending on the model
Protection class	598 × 335 × 990 mm
Dimensions	23.5 × 13.2 × 39 in vertical
Mounting position	



NOTE

Further technical information, technical drawings, accessories, spare parts or product function descriptions are available on SKF.com/lubrication:

PUB 3033 EN, 951-170-200-EN

Pump unit

FK

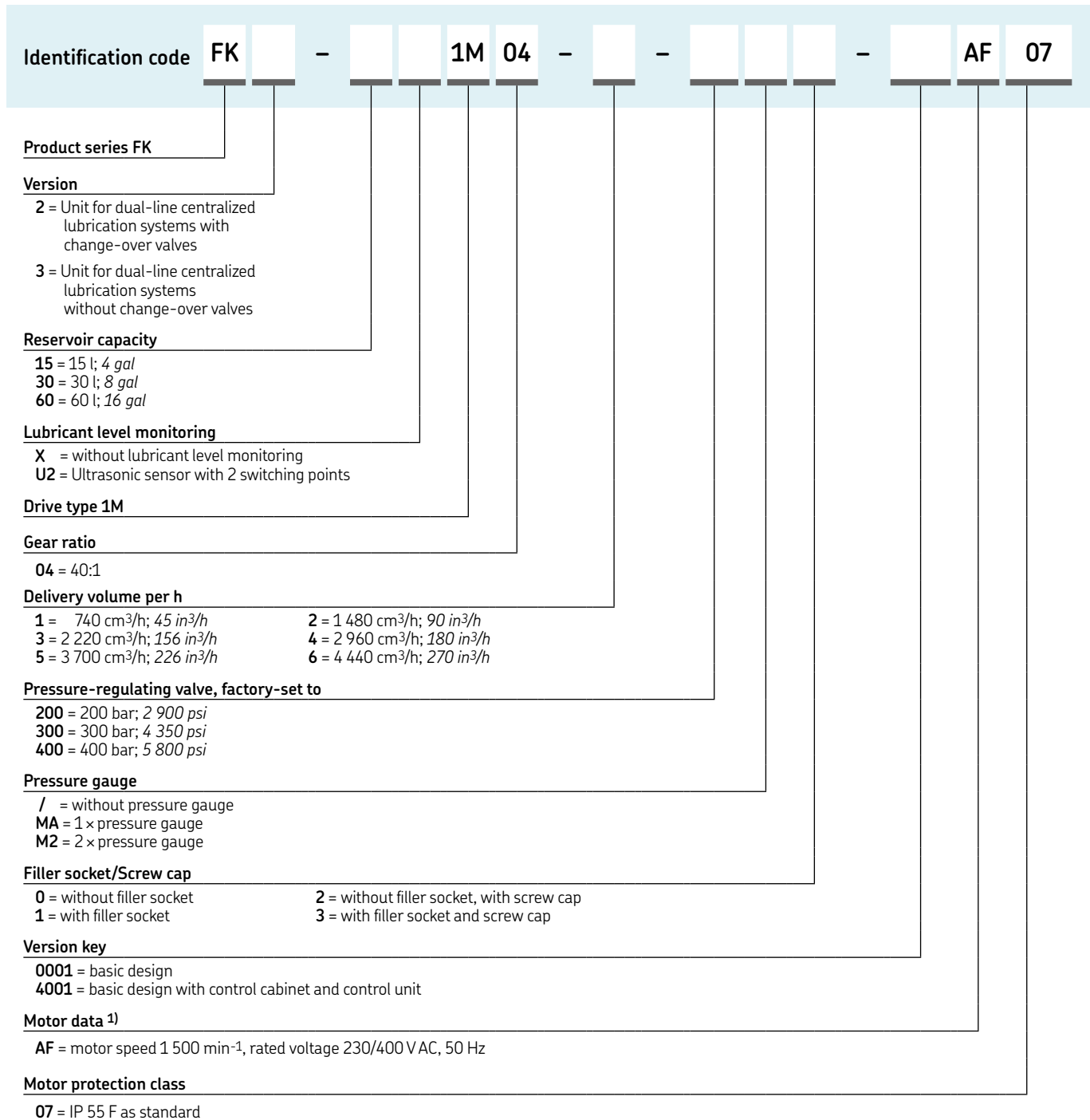

¹⁾ other specifications available on request

Pump unit

ZPU 08/14/24



Description

The ZPU 08/14/24 pumps are used primarily in dual-line systems or as supply pumps and have a maximum operating pressure of 400 bar (5 800 psi). Depending on the system layout, these electric pumps can supply lubricant at distances of up to 120 meters (131 yd) and more. Available with a 40 or 100 l (10 or 26 gal) reservoir, the pressure ZPU 08/14/24 pumps come standard with a pressure relief valve, check valve, lubricant filter and a pressure gauge. These robust units operate effectively at temperatures ranging from -20 to +80 °C (-4 to +176 °F) thanks to the integrated stirring device.

Features and benefits

- Reliable
- Simple to service
- Three options for high lubricant output
- Ultrasonic low- and high-level control options
- Built-in lubricant filter

Applications

- Cement plants
- Steel mills
- Power plants
- Mining
- Large machines

Technical data

Function principle	electrically operated piston pump
Drive speed	depending on model 60 – 180 min ⁻¹
Operating temperature	-20 to +80 °C, -4 to +176 °F
Lubricant	grease: up to NLGI 2, NLGI 3 on request oil: with a viscosity of min 20 mm ² /s
Metering quantity ¹⁾	ZPU 08: 8 000 cm ³ /h, 488 in ³ /h ZPU 14: 14 000 cm ³ /h, 855 in ³ /h ZPU 24: 24 000 cm ³ /h, 1 465 in ³ /h
Operating pressure	max. 400 bar, 5 800 psi
Reservoir capacity	40 or 100 l, 10 or 26 gal
Main line connection	G 3/4 female
Electrical connection	380–415V AC/50Hz, 420–480 V AC/60 Hz, 500 V AC/50 Hz
Protection class	IP 65
Dimensions	depending on the model min. 760 × 670 × 410 mm max. 975 × 825 × 500 mm min. 30 × 26 × 16 in max. 38.5 × 32.5 × 20 in
Mounting position	vertical

¹⁾ output increase by 20% for 60 Hz applications



NOTE

Further technical information, technical drawings, accessories, spare parts or product function descriptions are available on SKF.com/lubrication.

Pump unit

ZPU 08/14/24

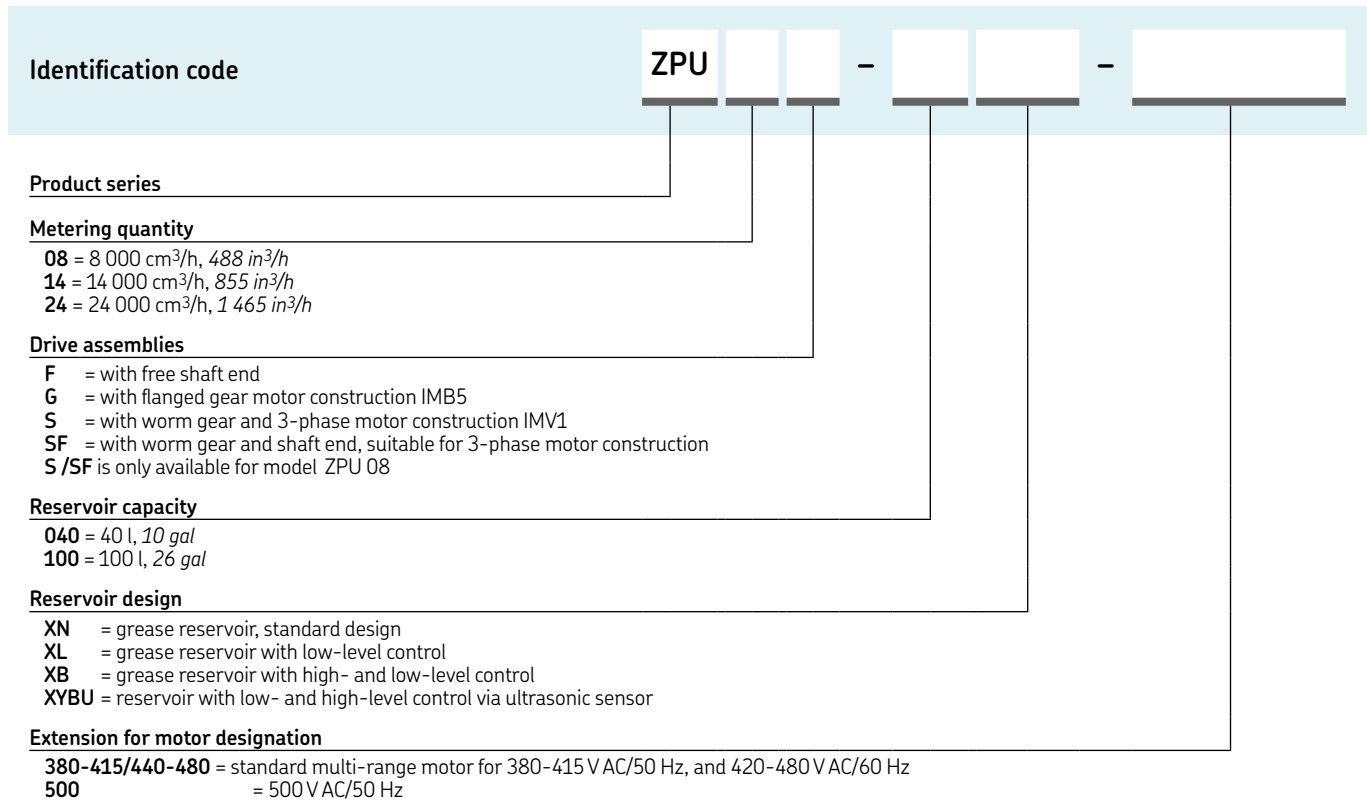

Pump unit

E-PUMP



Description

The electrical barrel pumping unit E-PUMP is a versatile barrel pump and it is especially designed for pumping oil or grease lubricants up to NLGI grade 2 into a centralized lubrication system. When equipped with a change-over valve unit, as E-VALV e.g. or a shut-off valve as E-VALVE-S e.g. it can be used either in single-line, dual-line or progressive lubrication systems. A complete pumping center consists of a pumping unit and a lid set. EPUMP-XXX-ECO coding is referring to ECO lid sets (descending pump head with follower plate), which are suitable for greases in NLGI grades 1 and 2 while EPUMP-XXX-STA coding is referring to STA lid sets (pump head always at barrel bottom), which are suitable for oil or greases in NLGI 0, 00 and 000 classes. To run E-PUMP accurately in dual-line lubrication systems an additional change-over valve needs to be implemented.

Features and benefits

- EPUMP models reflecting typical and often used barrel sizes
- Compact electrically operated pump for applications where no air supply is available
- An internal pressure control and a heating element secure the pump's function in high-pressure conditions and cold climates

Applications

- Heavy industries (paper, steel and other process industries)
- Mining and mineral processing
- Machinery workshops
- Food and beverage
- Cement industry



Technical data

Function principle	electrically operated pump
Outlets	1
Number of pump elements	4
Metering quantity	55 g/min; 0.3880136 oz/min
Operating temperature	-30 to +70 °C, -20 to 160 °F
Operating pressure	max. 240 bar, 3 480 psi
Lubricant	grease up to NLGI 2 oil up to 1 000 mm ² /s
Supply voltage	20-32 V DC
Power consumption	150 W
Heater	40W/24V, heater resistor for pump elements in ECO models LED's 5 yellow, 1 green, 1 red
Display	18, 50 and 180 kg, 40, 120 or 400 lb
Drum capacity	drum not included
Pressure sensor	50-240 bar adjustable in 25 bar steps 725.1 to 3480.9 psi in 362.6 psi steps
Protection class	IP 65
Dimensions	depending on the model min. 400 × 400 × 800 mm max. 400 × 400 × 1 300 mm min. 15.75 × 15.75 × 31.49 in max. 15.75 × 15.75 × 51.18 in
Mounting position	vertical



NOTE

Further technical information, technical drawings, accessories, spare parts or product function descriptions are available on SKF.com/lubrication.

Pump unit

E-PUMP

Order information

Order number	Designation	Lubricant	Control	Suitable barrel size	
				kg	lb
12375180	SKF-EPUMP-1/8-ECO-24-CC	Grease up to NLGI 2	external control unit	18	40
12375100	SKF-EPUMP-1/4-ECO-24-CC	Grease up to NLGI 2	external control unit	50	120
12375020	SKF-EPUMP-1/1-ECO-24-CC	Grease up to NLGI 2	external control unit	180	400

Accessories

Lid sets for grease barrels



Lid sets for grease barrels

Order number	Designation	Lubricant	for barrel size	
			kg	lb
12381280	E-LIDSET-1/8-ECO	Grease	18	40
12381285	E-LIDSET-1/4-ECO	Grease	50	120
12381290	E-LIDSET-1/1-ECO	Grease	180	400

Pump unit

MPB



Description

The MPB pump unit is especially designed for automatic lubrication systems. The unique feature in it compared to traditional air-operated barrel pump with mechanical air motor valve is its magnetically operated air motor valve. This will reduce the amount of mechanical components in the air motor and also eliminates the need of lubrication in the air motor. The pump is suitable for use with 18, 50 and 180 kg (40, 120 and 400 lb) lubricant barrels. And when equipped with a suitable adapter MPB pump unit can also be used in lubricant bulk containers.

Features and benefits

- Lubrication-free, air motor
- Fewer mechanical components extend a service life of the air motor
- Operates effectively in wide range of temperatures
- IP 65 protection rating

Applications

- Paper industry
- Steel industry
- Heavy industry

Technical data

Function principle	air operated piston pump for barrels
Metering quantity	850 g/min; 30 oz/min 5,5 g/stroke; 0.2 oz/stroke
Operating temperature	-10 to +55 °C, 14 to 131 °F
Operating pressure	max. 300 bar, 4 350 psi
Pressure ratio	1:65
Pressure air supply	2 to 4,5 bar, 29 to 65 psi
Air consumption	max. 300 l/min; 80 gal/min
Lubricant	grease up to NLGI 2 oil up to 10 000 mm ² /s
Drum capacity	18, 50 and 180 kg, 40, 120 or 400 lb drum not included
Protection class	IP 65
Dimensions	depending on the model min. 650 × 130 × 130 mm max. 920 × 130 × 130 mm min. 25.6 × 5.11 × 5.11 in max. 36.22 × 5.11 × 5.11 in vertical
Mounting position	vertical



NOTE

Further technical information, technical drawings, accessories, spare parts or product function descriptions are available on SKF.com/lubrication:

PUB LS/P8 17178 EN

Pump unit

MPB

Order information

Order number	Designation	Suitable barrel size	
		kg	lb
12381702	SKF-MPB-PUMP-1/8	18	40
12381701	SKF-MPB-PUMP-1/4	50	120
12381700	SKF-MPB-PUMP-1/1	180	400

Accessories

Air regulator unit



Air regulator unit

Order number	Designation
12382666	MAX-V2-SET-MPB

Lid sets



Lid sets

Order number	Designation	Suitable barrel size	
		kg	lb
12381383	MAXV2-LIDSET-1/8-ECO-MPB	18	40
12381382	MAXV2-LIDSET-1/4-ECO-MPB	50	120
12381381	MAXV2-LIDSET-1/1-ECO-MPB	180	400
12381386	MAXV2-LIDSET-1/8-STA-MPB	18	40
12381385	MAXV2-LIDSET-1/4-STA-MPB	50	120
12381384	MAXV2-LIDSET-1/1-STA-MPB	180	400

Pump unit

Lubrigun



Description

The performance-proven Lubrigun air-operated pump units are found in industrial facilities worldwide. Ideal for high-pressure applications, these pumps include a powerful displacement air motor with 63,5 mm (2.5 in) stroke and are available for 50 kg (120 lb) and 180 kg (400 lb) drums. For dual-line applications, the Lubrigun utilizes a pump hoist, return-line connection, low-level switch, maintenance unit and connection hoses.

Features and benefits

- Lightweight, zinc head casting design for corrosion resistance
- One-piece pump outlet body withstands high lubricant pressure
- Double-acting design provides high pressure and uniform delivery on both up and down strokes
- Integrated, patented muffler minimizes noise
- Pre-lubricated air motor requires no external oiler
- Pneumatically assisted mechanical air valve for positive priming
- Hardened steel plunger and bushing resist abrasion and extend pump life

Applications

- Power plants
- Mining equipment
- Cement plants

Technical data

Function principle	air-operated piston pump unit for barrels
Operating temperature	-34 to +93 °C, -30 to +200°F
Operating pressure	max. 515 bar, 7 500 psi
Lubricant	NLGI 1 and 2
Cycles per minute ¹⁾	max. 120
Metering quantity per cycle	5,7 cm ³ , 0.35 in ³
Pressure ratio	50:1
Lubricant outlet connection	1/4 NPTF
Dimensions with pump lift	950 × 700 × 2 800 mm 374 × 275 × 1 102 in
Mounting position	vertical

¹⁾ generally approx. 50 cycles/min are assumed

Order information

Order number	Designation
82054	Lubrigun barrel pump, 180 kg, 400 lb
82050	Lubrigun barrel pump, 50 kg, 120 lb

NOTE

Further technical information, technical drawings, accessories, spare parts or product function descriptions are available on SKF.com/lubrication.

Lubrigun

001709



Pump hoist

Order number	Designation
001709	pump hoist without pump

Description

Ideal for easy and clean drum change-over. Used for fast power-operated drum changing. Lifts any air-operated pump with a 60 or 200 l (15 or 55 lb) drum and lowers it into another. Can serve one or a cluster of drums from one location.

274681



Single-post primer

Order number	Designation
274681	single-post primer without pump

Description

For use with Lubrigun pumps, air-operated single-post pump hoist for 200 l (55 gal) drums performs several functions in applications of low- to medium-viscosity materials. The primer facilitates drum change-overs and includes a follower and wiper that use normal suction to help maintain pump prime. The unit also includes a mounting bracket suitable for all Lubrigun pump units.

Pump unit

PowerMaster III



Description

Designed to fit large drums or containers, PowerMaster III pump units are ideal for lubrication systems using substantial quantities of lubricant. The modular combination of various air motors with pump tubes enables optimum adaptation to lubrication system requirements. The PowerMaster III is available in carbon steel to fit any drum size. A complete line of priming equipment and mounting devices are offered.

Features and benefits

- Uses air motors with diameters of 76, 101, 152 and 203 mm (3, 4, 6 or 8 in)
- Full 152 mm (6 in) stroke for greater output per cycle
- Modular design for easy repair
- Only five moving parts and no metal-to-metal contact for longer service life
- Pump tubes provide ratios and outputs for any application
- Hydraulically operated drive motors offered for lubrication systems on hydraulic excavators
- Shovel-foot-style for high-viscosity, non-fluid materials

Applications

- Hydraulic excavators
- Sinter plants
- Beverage bottling plants

Technical data

Function principle	air-operated piston pump unit for barrels
Operating temperature	-34 to +93 °C, -30 to +200 °F
Operating pressure	max. 500 bar, 7 300 psi
Lubricant	NLGI 1 and 2
Cycles per minute	max. 70
Metering quantity per cycle	34–60,5 cm ³ , 2.1–3.7 in ³
Pressure ratio	50:1, 75:1 (recommended for lubrication systems)
Lubricant outlet connection	3/4 NPTF
Dimensions	950 × 700 × 2 800 mm 374 × 275 × 1 103 in
Mounting position	vertical

Order information

Order number	Designation
84804	PowerMaster III air motor model (ratio 75:1)
84997	PowerMaster III barrel pump with pump tube
84723	PowerMaster III air motor cover kit



NOTE

Further technical information, technical drawings, accessories, spare parts or product function descriptions are available on SKF.com/lubrication:

PUB 15169 EN

PowerMaster III

001709



Pump hoist

Order number	Designation
001709	single-post primer elevator

Description

This single-post elevator is ideal for quick and easy power-operated drum changes. Lifts any air-operated pump from 60 and 200 l, 15 or 55 lb drum and lowers it into another. Can serve one or a cluster of drums from one location.

84827, 84785, 83286



Single post primer

Order number	Designation
84827	pump hoist
84785	support-bracket
83286	follower assembly

Description

For use with PowerMaster III Series 2000 pumps, this air-operated, single-post pump hoist for 200 l (55 gal) drums performs several functions in applications of low- to medium-viscosity materials. The primer facilitates drum changeovers and includes a follower and wiper that use normal suction to help maintain pump prime. The unit also includes a mounting bracket for all PowerMaster III pumps.

84723



Air motor cover panel kit

Order number	Designation
84723	series III air motor cover panel kit

Description

Metal cover fits tie rods and encloses the moving plunger rod.

Pump unit

BPH



Description

The hydraulically operated barrel pump series BPH offers all features needed to run the machine without unplanned interruptions. Constructed of heavy-duty material, the pump works reliable in demanding applications, including excavators, loaders, haul trucks and other heavy machinery in construction and mining environment. Featuring a fully encased pump head, damages during tough operation become less likely. The compact design allows to mount the pump even in applications, where space is limited. While hindering fluids to leak, the three-sealing-package provides the extra step to safe and reliable operation. In addition, it minimizes the risk of contamination of hydraulic oils as well as environmental concerns. Flow rate and reverse pressure can be adjusted to fit the application needs. Built-in sensors monitor oil pressure, temperature and piston movement helping to avoid malfunction prior the event.

Features and benefits

- Innovative sealing concept to avoid hydraulic oil and lubrication grease leakage
- Three possible outlet directions, front, left and right
- Compact and robust design for demanding applications
- Optional monitoring sensors for increased reliability

Applications

- Construction machinery
- Mining machinery

Technical data

Order numbers:	
BPH30 pump basic	BPH30-3001AB-VAOM
BPH30 pump with sensors	BPH30-3101AB-VAOM
Function principle	hydraulically operated barrel pump
Outlets	1
Metering quantity	30 cm ³ /stroke; 1.83 in ³ /stroke 360 cm ³ /min; 22 in ³ grease NLGI 0, 1, 2
Lubricant	
Operating temperature	-40 to +80 °C; -40 to +176 °F
Operating back pressure	max. 320 bar, 4 642 psi
Transmission ratio	min. 10:1
Required viscosity of the hydraulic oil	13 mm – 380 mm ² /s
Nominal oil pressure	35–120 bar; 508–1 740 psi
Suitable barrels	208 l; 55 gal
Material	steel, FKM (FPM), NBR
Corrosion class	C3
Connection outlet	3/4 NPTF (F) or M27×2
Hydraulic oil inlet	G 3/8
Protection class	IP 65
Dimensions	245 × 155 × 1 260 mm 9.6 × 6.1 × 50 in
Mounting position	upright

Pump requires 3-way air valve
Air consumption at 6,9 bar, 100 psi, is 0,004 M³/min, 0.15 ft³/min, per stroke



NOTE

Further technical information, technical drawings, accessories, spare parts or product function descriptions available on SKF.com/lubrication.

PUB LS/P2 19079 EN, 951-171-060-EN

Pump unit

BPH

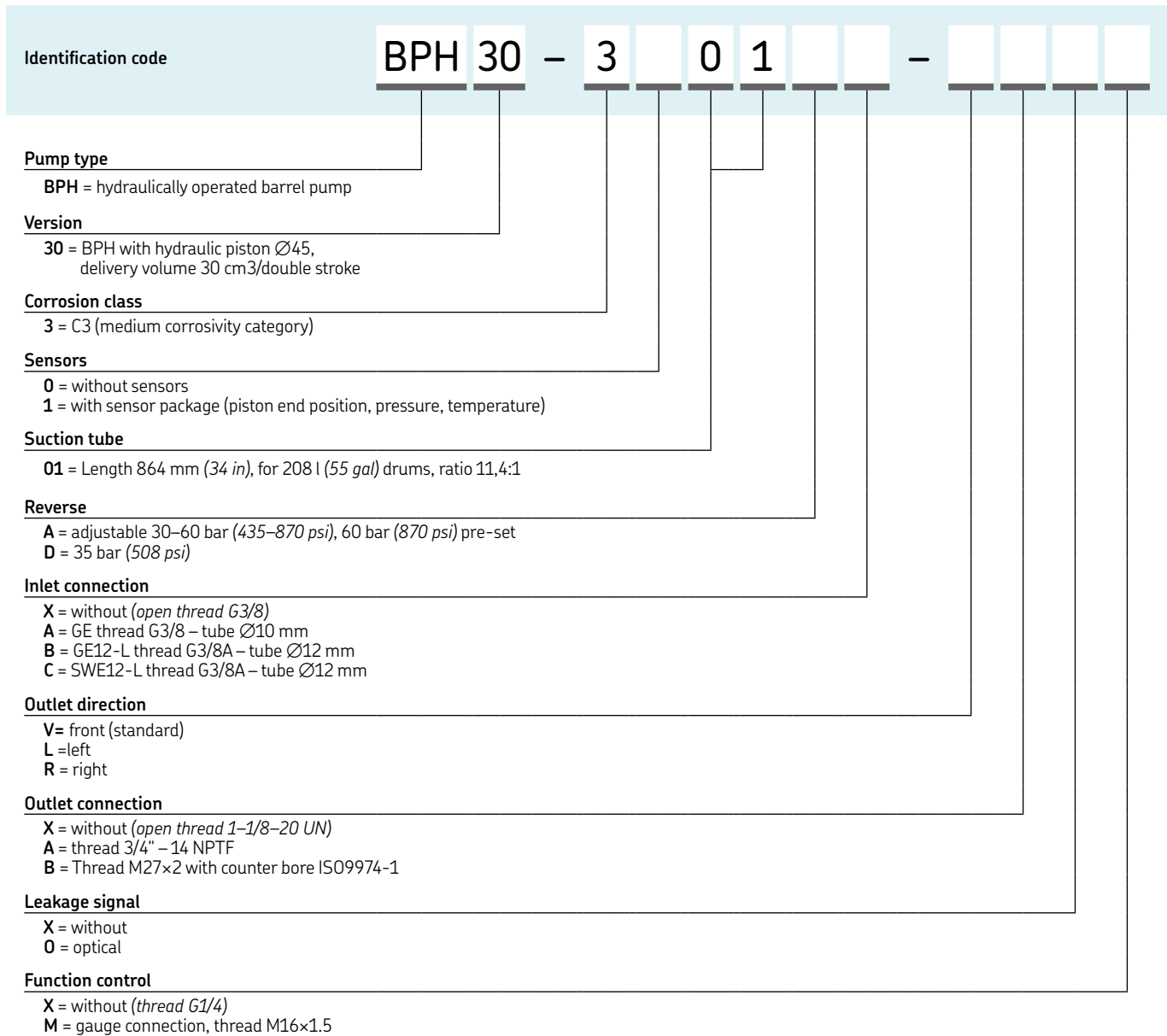

Order information

Order number	Description
BPH30-3001AB-VAOM ¹⁾	BPH30 pump, basic without sensors
BPH30-3101AB-VAOM ¹⁾	BPH30 pump, basic with sensors

¹⁾ Basic pump versions include:

- Corrosion class C3
- Suction tube 01 for drum size 55 gal / 208 liter
- Adjustable reverse pressure 30–60 bar (435–870 psi)
- Inlet connection GE12-L thread G3/8A – tube Ø12
- Front outlet direction
- Outlet connection thread 3/4" – 1/4 NPTF
- Optical leakage signal
- Function monitoring control with pressure gauge

Spare parts

Order number	Description
4090-00000011	Housing
5090-00000001	Pump tube
5090-00000013	Pressure control valve
2350-00000077	Flow control valve
6640-00000046	Cable harness
5090-00000012	Hydraulic piston Ø45 mm complete
5090-00000005	Sealing housing
5090-00000011	Leakage monitoring
6640-00000064	Proximity switch 10–30 V DC with plug
2340-00000083	Pressure sensor 10–30 V DC
6640-00000065	Temperature probe PT100 with plug

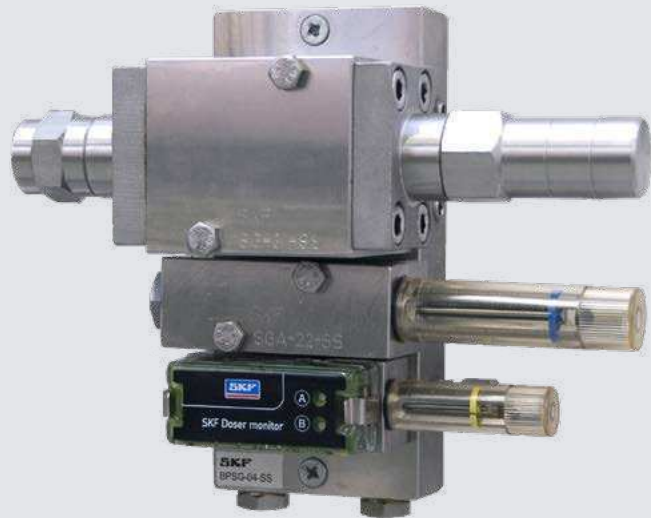

Overview of metering devices

Block design metering devices							
Product	Material housing and design	Operation pressure max.		Outlets	Metered quantity per stroke		Page
		bar	psi		cm ³	in ³	
	steel galvanized or stainless steel	bar	psi		cm ³	in ³	
SMG	steel galvanized	200	2 900	1-8	0,13-1,32	0.008-0.08	32
VSKH-KR	with indicator pin, adjustable output	400	5 800	1-8	0-1,5	0-0.09	34
VSKH-KRFBM	with FKM seals	400	5 800	1-8	0-1,5	0-0.09	34
VSKV-KR	with indicator pin, adjustable output	400	5 800	1-8	0-1,5	0-0.09	34
VSKV-KRFBM	with FKM seals	400	5 800	1-8	0-1,5	0-0.09	34
VSG-KR	with indicator pin, adjustable output	400	5 800	1-8	0-2,2	0-0.13	38
VSG-KRFBM	with FKM seals	400	5 800	1-8	0-2,2	0-0.13	38
VSG-KR-NP	with piston detector	400	5 800	1-8	0-2,2	0-0.13	38
VSG-KR-KA	with adapter for limit switch	400	5 800	2, 4, 6, 8	0-2,2	0-0.13	38
VSG-KR-KS	with limit switch	400	5 800	1-8	0-2,2	0-0.13	38
VSG-KR-KD, D	with fixed metering screw	400	5 800	1-8	0,55; 1,1; 1,65; 2,2	0.04, 0.07, 0.1, 0.13	38
VSL-KR	with indicator pin, adjustable output	400	5 800	1-8	0-5	0-0.3	42
VSL-KR-FKM	with FKM seals	400	5 800	1-8	0-5	0-0.3	42
VSL-KR-NP	with piston detector	400	5 800	1-8	0-5	0-0.3	42
VSL-KR-KA	with adapter for limit switch	400	5 800	2, 4, 6, 8	0-5	0-0.3	42
VSL-KR-KS	with limit switch	400	5 800	1-8	0-5	0-0.3	42
VSL-KR-KD, D	with fixed metering screw	400	5 800	1-8	1,25; 2,5; 3,75; 5	0.07, 0.15, 0.23, 0.3	42

Modular design metering devices							
Product	Material housing and design	Operation pressure max.		Outlets ¹⁾	Metered quantity per stroke		Page
		bar	psi		cm ³	in ³	
	steel galvanized or stainless steel	bar	psi		cm ³	in ³	
SGA	with indicator pin, adjustable output	250	3 600	1-12	0,17-4,85	0.01-0.29	46
SG	with indicator pin, adjustable output	250	3 600	1-12	4,88-98	0.29-5.98	46

¹⁾ Metering device outlets 1 or 2, metering device groups up to 12 outlets (on top of base plate BPSG)

Metering device

SMG

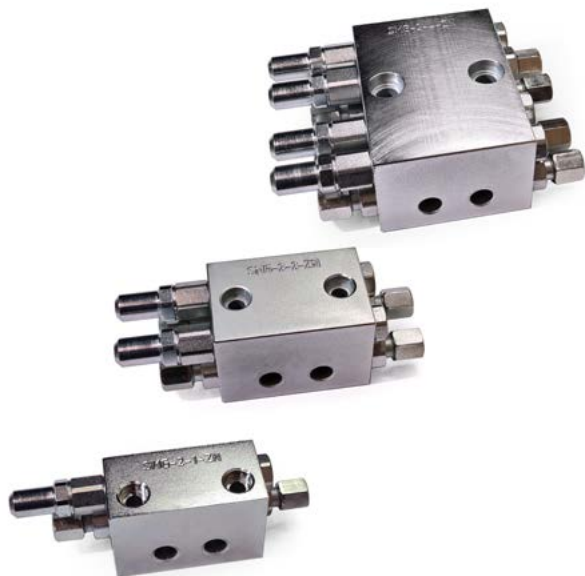

Description

SMG dual-line grease metering devices are designed for demanding off-highway applications requiring high reliability and redundancy. Metering devices are made of zinc-coated carbon steel and include built-in check valves and adjustment to achieve precise dosage. The dosages can be adjusted from 130 to 1 500 mm³.

Features and benefits

- Adjustable metering quantity
- Solid-block construction for harsh conditions
- Operates effectively even on sub zero temperatures
- Lubrication pipe connectors included for easy mounting

Applications

- Heavy construction machinery
- Forestry harvesters and machines
- Dump truck and mining machinery



Technical data

Function principle	dual-line metering devices
Outlets	1-8
Operating temperature	-35 to 80 °C, -31 to +176 °F
Lubricant	grease up to NLGI 3
Operating pressure	max. 200 bar, 2 900 psi
Materials	zinc-coated steel
Metering quantity per stroke	0,13–1,32 cm ³ , 0,008–0,08 in ³
Main line connection inlet	G ¹ / ₈ or NPT ¹ / ₈
Outlet connection	R ¹ / ₈ , NPT ¹ / ₈ or Ø6 mm pipe fitting (female)
Dimensions	
SMG-2-1	120 × 41 × 30 mm; 4.72 × 1.61 × 1.18 in
SMG-2-2	120 × 41 × 40 mm; 4.72 × 1.61 × 1.57 in
SMG-2-4	120 × 41 × 80 mm; 4.72 × 1.61 × 3.14 in
Mounting position	any



NOTE

Further technical information, technical drawings, accessories, spare parts or product function descriptions are available on SKF.com/lubrication.

Metering device

SMG

Order information

Order number	Designation	Outlets	Outlet connection	Material
11391525	SMG-2-1-ZN	2	R ¹ / ₈	zinc-coated steel
11391530	SMG-2-2-ZN	4	Ø6 mm pipe connector	zinc-coated steel
11391535	SMG-2-4-ZN	8	Ø6 mm pipe connector	zinc-coated steel
12800350	SMG-2-1-ZN-U	2	NPT ¹ / ₈	zinc-coated steel
12800360	SMG-2-2-ZN-U	4	Ø6 mm pipe connector	zinc-coated steel
12800370	SMG-2-4-ZN-U	8	Ø6 mm pipe connector	zinc-coated steel

Metering device

VSKH/VSKV



Description

The durable, galvanized steel VSK metering devices are designed for dual-line systems with pressures of up to 400 bar (5 800 psi). These metering devices are available with up to eight outlets, and each pair of outlets is equipped with an indicator pin for visual monitoring. Also, the VSK metering devices are available with low-wear proximity switches, or piston detectors, for electrical monitoring (except VSK..-D version). Additional features include rust-resistant material or rust- and acid-resistant material.

Features and benefits

- Solid-block construction for durability and error-free exchange
- Operates effectively in a wide range of temperatures
- Easy to monitor
- Available with horizontal VSKH outlets or vertical VSKV outlets for limited installation conditions
- Optional available piston detectors and limit switches

Applications

- Cement plants
- Mining excavators
- Steel plants

Technical data

Function principle	metering devices
Outlets	1-8
Operating temperature	KR: max. +80 °C, +176 °F MD, KR-FKM: max. +120 °C, +248 °F
Operating pressure	max. 400 bar, 5 800 psi
Lubricant	grease up to NLGI 3, oil with a viscosity of min. 20 mm ² /s
Materials	carbon steel galvanized or stainless steel
Metering quantity per stroke	0-1,5 cm ³ , 0-0.09 in ³ or fixed output Version D: 0,3; 0,6; 1,2; 1,5 cm ³ 0.018; 0.037; 0.073; 0.092 in ³ order numbers on request
Main line connection inlet	G 1/4
Outlet connection	G 1/4
Dimensions	depending on the model: min. 124 × 52 × 57 mm max. 124 × 136 × 57 mm min. 4.88 × 2.05 × 2.24 in max. 4.88 × 5.35 × 2.24 in

NOTE

Further technical information, technical drawings, accessories, spare parts or product function descriptions are available on SKF.com/lubrication.

3D

skf-lubrication.partcommunity.com/3d-cad-models

Metering device

VSKH/VSKV

VSKH and VSKV, with connection thread BSPP

Order number		Outlets	Material			Indicator pin adjustable output 0–1,5 cm ³ (0–0.09 in ³)	
VSKH-KR ..	VSKV-KR ..		Steel galvanized	Stainless steel 1.4305/303	Stainless steel 1.4571/316 Ti	KR	FKM U-cup seal
620-27438-1	620-27442-1	1	•	–	–	•	–
620-27418-1	620-27422-1	2	•	–	–	•	–
620-27439-1	620-27443-1	3	•	–	–	•	–
620-27419-1	620-27423-1	4	•	–	–	•	–
620-27440-1	620-27444-1	5	•	–	–	•	–
620-27420-1	620-27424-1	6	•	–	–	•	–
620-27441-1	620-27445-1	7	•	–	–	•	–
620-27421-1	620-27425-1	8	•	–	–	•	–
620-27488-1	620-27496-1	1	–	•	–	•	–
620-27489-1	620-27497-1	2	–	•	–	•	–
620-27490-1	620-27498-1	3	–	•	–	•	–
620-27491-1	620-27499-1	4	–	•	–	•	–
620-27492-1	620-27500-1	5	–	•	–	•	–
620-27493-1	620-27501-1	6	–	•	–	•	–
620-27494-1	620-27502-1	7	–	•	–	•	–
620-27495-1	620-27503-1	8	–	•	–	•	–
620-27766-1	620-27857-1	1	–	–	•	•	–
620-27767-1	620-27858-1	2	–	–	•	•	–
620-27768-1	620-27859-1	3	–	–	•	•	–
620-27769-1	620-27860-1	4	–	–	•	•	–
620-27770-1	620-27861-1	5	–	–	•	•	–
620-27771-1	620-27862-1	6	–	–	•	•	–
620-27772-1	620-27863-1	7	–	–	•	•	–
620-27773-1	620-27864-1	8	–	–	•	•	–
620-28409-1	620-28413-1	1	•	–	–	•	•
620-28376-1	620-28392-1	2	•	–	–	•	•
620-28410-1	620-28414-1	3	•	–	–	•	•
620-28366-1	620-28393-1	4	•	–	–	•	•
620-28411-1	620-28415-1	5	•	–	–	•	•
620-28367-1	620-28374-1	6	•	–	–	•	•
620-28412-1	620-28416-1	7	•	–	–	•	•
620-28391-1	620-28394-1	8	•	–	–	•	•

VSKH-MD.. , with connection thread BSPP

Order number	Outlets	Material				Metering quantity max.	
			Metering device	Regulating sleeve	Protection cap	cm ³	in ³
620-41086-1	2	steel, galvanized		brass	brass	1,50	0.09
620-41122-1	2	steel, galvanized		brass	plastic	1,50	0.09
620-41086-5	3	steel, galvanized		brass	brass	1,50	0.09
620-41086-2	4	steel, galvanized		brass	brass	1,50	0.09
620-41122-2	4	steel, galvanized		brass	plastic	1,50	0.09
620-41086-6	5	steel, galvanized		brass	brass	1,50	0.09
620-41086-3	6	steel, galvanized		brass	brass	1,50	0.09
620-41122-3	6	steel, galvanized		brass	plastic	1,50	0.09
620-41086-7	7	steel, galvanized		brass	brass	1,50	0.09
620-41086-4	8	steel, galvanized		brass	brass	1,50	0.09
620-41122-4	8	steel, galvanized		brass	plastic	1,50	0.09

Metering device

VSKH/VSKV

VSKV-MD.. , with connection thread BSPP

Order number	Outlets	Material			Metering quantity max.	
		Metering device	Regulating sleeve	Protection cap	cm ³	in ³
620-41123-2	2	steel, galvanized	brass	plastic	1,50	0.09
620-41089-2	2	steel, galvanized	brass	brass	1,50	0.09
620-41123-4	4	steel, galvanized	brass	plastic	1,50	0.09
620-41089-4	4	steel, galvanized	brass	brass	1,50	0.09
620-41123-6	6	steel, galvanized	brass	plastic	1,50	0.09
620-41089-6	6	steel, galvanized	brass	brass	1,50	0.09
620-41123-8	8	steel, galvanized	brass	plastic	1,50	0.09
620-41089-8	8	steel, galvanized	brass	brass	1,50	0.09

Accessories

Metering screw for VSKH/VSKV

Order number	Output		Material
	cm ³	in ³	
303-19351-1	0,30	0.018	Steel
303-19352-1	0,60	0.037	Steel
303-19354-1	1,20	0.073	Steel
303-19375-1	1,50	0.091	Steel
303-19356-1	0,30	0.018	Stainless steel 1.4571/316 Ti
303-19357-1	0,60	0.037	Stainless steel 1.4571/316 Ti
303-19359-1	1,20	0.073	Stainless steel 1.4571/316 Ti
303-19374-1	1,50	0.091	Stainless steel 1.4571/316 Ti

Extensions for VSK, VSG and VSL

Order number	Model
420-23628-1	VSKH
420-23790-1	VSKH, 1.4305

Accessories

VSKH/VSKV

520-33075-1



Magnetic indicator for VSKH/VSKV

Order number	Output setting		Protection cap material
	cm ³	in ³	
520-33109-1	0,30	0.018	Brass
520-33110-1	0,60	0.037	Brass
520-33112-1	1,20	0.073	Brass
520-33075-1	1,50	0.091	Brass
520-33266-1	0,30	0.018	Plastic
520-33267-1	0,60	0.037	Plastic
520-33268-1	1,20	0.073	Plastic
520-33269-1	1,50	0.091	Plastic

VSG4-KR with welding plate and extension



Welding plates for VSK, VSG and VSL

Order number	Model
432-23698-1	VSK2
432-23699-1	VSK4
432-23700-1	VSK6
432-23701-1	VSK8
432-21791-1	VSG2/VSL2
432-21792-1	VSG4/VSL4
432-21793-1	VSG6/VSL6
432-21794-1	VSG8/VSL8

223-13052-1



Check valve

Order number	Tube	Designation
	Ø mm	
223-13052-1	6	GERV 6-S G 1/4 AVCF
223-13052-2	8	GERV 8-L G 1/4 AVCF
223-13052-3	10	GERV 10-L G 1/4 AVCF

Metering device

VSG

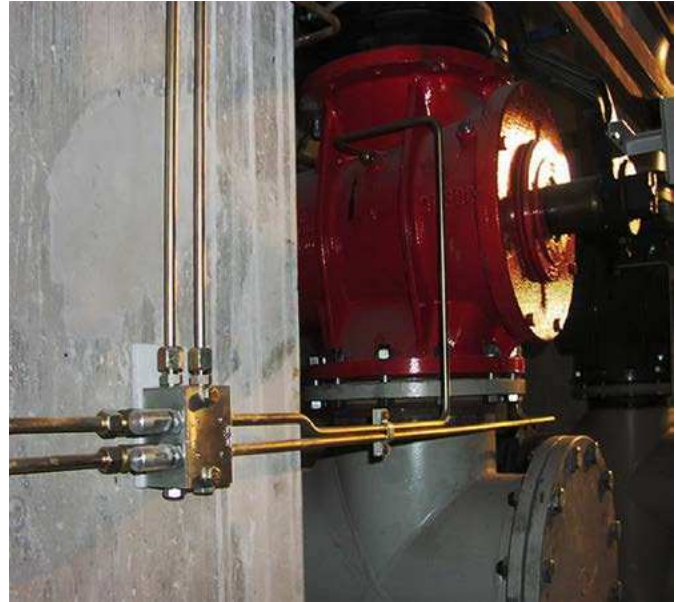

Description

The durable, galvanized steel VSG metering devices are designed for dual-line systems with pressures of up to 400 bar (5 800 psi). These metering devices are available with up to eight outlets, and each pair of outlets is equipped with an indicator pin for visual monitoring. Also, the VSG metering devices are available with low-wear proximity switches, or piston detectors, for electrical monitoring (except VSG-D version). Additional features include rust-resistant material or rust- and acid-resistant material.

Features and benefits

- Easy cross-porting with external screw to combine
- Solid-block construction for durability and error-free exchange
- Operates effectively in a wide range of temperatures
- Easy to monitor

Applications

- Steel plants
- Cement plants
- Mining excavators

Technical data

Function principle	metering devices
Outlets	1-8
Operating temperature	KR-..., KD, D: max. +80 °C, +176 °F MD, KR-FKM: max. +120 °C, +248 °F
Lubricant	grease up to NLGI 3, oil with a viscosity of min. 20 mm ² /s
Operating pressure	max. 400 bar, 5 800 psi
Materials	carbon steel galvanized or stainless steel
Metering quantity per stroke	0-2,2 cm ³ , 0-0.13 in ³ or fixed output Version D: 0,55; 1,1; 1,65; 2,2 cm ³ , 0,033; 0,067; 0,01; 0,13 in ³ order numbers on request
Main line connection inlet	G 3/8, 3/8 NPTF
Outlet connection	G 1/4, 1/4 NPTF
Dimensions	min. 148 × 94 × 54 mm max. 148 × 190 × 54 mm min. 5.83 × 3.70 × 2.13 in max. 5.83 × 7.48 × 2.13 in



NOTE

Further technical information, technical drawings, accessories, spare parts or product function descriptions are available on SKF.com/lubrication.



3D

skf-lubrication.partcommunity.com/3d-cad-models

Metering device

VSG

VSG		Outlets	Material Steel galvanized	Stainless steel 1.4305/303	Stainless steel 1.4571/316Ti	Indicator pin adjustable output	
Order number BSPP	NPTF					KR	FKM U-cup seal
620-40022-1	620-40022-2	1	•	–	–	•	–
620-40015-1	620-40015-2	2	•	–	–	•	–
620-40022-3	620-40022-4	3	•	–	–	•	–
620-40015-3	620-40015-4	4	•	–	–	•	–
620-40022-5	620-40022-6	5	•	–	–	•	–
620-40015-5	620-40015-6	6	•	–	–	•	–
620-40022-7	620-40022-8	7	•	–	–	•	–
620-40015-7	620-40015-8	8	•	–	–	•	–
620-40567-1	–	1	–	•	–	•	–
620-40567-2	–	2	–	•	–	•	–
620-40567-3	–	3	–	•	–	•	–
620-40567-4	–	4	–	•	–	•	–
620-40567-5	–	5	–	•	–	•	–
620-40567-6	–	6	–	•	–	•	–
620-40567-7	–	7	–	•	–	•	–
620-40567-8	–	8	–	•	–	•	–
620-40839-1	–	1	–	–	•	•	•
620-40839-2	–	2	–	–	•	•	•
620-40839-3	–	3	–	–	•	•	•
620-40839-4	–	4	–	–	•	•	•
620-40839-5	–	5	–	–	•	•	•
620-40839-6	–	6	–	–	•	•	•
620-40839-7	–	7	–	–	•	•	•
620-40839-8	–	8	–	–	•	•	•
620-40525-2	–	1	•	–	–	•	•
620-40525-1	–	2	•	–	–	•	•
620-40525-3	–	3	•	–	–	•	•
620-40525-4	–	4	•	–	–	•	•
620-40525-5	–	5	•	–	–	•	•
620-40525-6	–	6	•	–	–	•	•
620-40525-7	–	7	•	–	–	•	•
620-40525-8	–	8	•	–	–	•	•

Metering device

VSG

Order numbers VSG

Connection thread		Outlets	Material Steel galvanized	Indication and monitoring		Adapter for limit switch KA ¹⁾	Limit switch KS	Indicator pin; fixed output; metering screws KD ²⁾	Metering screws D ²⁾
BSP	NPTF			Indicator pin adjustable KR	Piston detector NP				
620-40733-1	-	1	•	•	•	-	-	-	-
620-40733-2	-	2	•	•	•	-	-	-	-
620-40733-3	-	3	•	•	•	-	-	-	-
620-40733-4	-	4	•	•	•	-	-	-	-
620-40733-5	-	5	•	•	•	-	-	-	-
620-40733-6	-	6	•	•	•	-	-	-	-
620-40733-7	-	7	•	•	•	-	-	-	-
620-40733-8	-	8	•	•	•	-	-	-	-
620-40605-1	-	1	•	•	-	•	-	-	-
620-40605-2	-	2	•	•	-	•	-	-	-
620-40605-3	-	3	•	•	-	•	-	-	-
620-40605-4	-	4	•	•	-	•	-	-	-
620-40027-1	620-40027-2	1	•	•	-	-	•	-	-
620-40027-3	620-40027-4	2	•	•	-	-	•	-	-
620-40027-5	620-40027-6	3	•	•	-	-	•	-	-
620-40027-7	620-40027-8	4	•	•	-	-	•	-	-
620-40028-1	620-40028-2	5	•	•	-	-	•	-	-
620-40028-3	620-40028-4	6	•	•	-	-	•	-	-
620-40028-5	620-40028-6	7	•	•	-	-	•	-	-
620-40028-7	620-40028-8	8	•	•	-	-	•	-	-
620-40023-1	620-40023-2	1	•	-	-	-	-	•	-
620-40023-3	620-40023-4	2	•	-	-	-	-	•	-
620-40023-5	620-40023-6	3	•	-	-	-	-	•	-
620-40023-7	620-40023-8	4	•	-	-	-	-	•	-
620-40024-1	620-40024-2	5	•	-	-	-	-	•	-
620-40024-3	620-40024-4	6	•	-	-	-	-	•	-
620-40024-5	620-40024-6	7	•	-	-	-	-	•	-
620-40024-7	620-40024-8	8	•	-	-	-	-	•	-
620-40025-1	620-40025-2	1	•	-	-	-	-	-	•
620-40025-3	620-40025-4	2	•	-	-	-	-	-	•
620-40025-5	620-40025-6	3	•	-	-	-	-	-	•
620-40025-7	620-40025-8	4	•	-	-	-	-	-	•
620-40026-1	620-40026-2	5	•	-	-	-	-	-	•
620-40026-3	620-40026-4	6	•	-	-	-	-	-	•
620-40026-5	620-40026-6	7	•	-	-	-	-	-	•
620-40026-7	620-40026-8	8	•	-	-	-	-	-	•

¹⁾ thread M12x1

²⁾ fixed output 0,55; 1,1; 1,65; 2,2 cm³; 0,033; 0,067; 0,01; 0,13 in³

Check valves

Order number	Tube	Designation
	∅ mm	
223-13052-1	6	GERV 6-S G 1/4 AVCF
223-13052-2	8	GERV 8-L G 1/4 AVCF
223-13052-3	10	GERV 10-L G 1/4 AVCF

Metering device

VSG

VSG-MD.. , with connection thread BSPP

Order number	Outlets	Material				Metering quantity max.	
			Metering device	Regulating sleeve	Protection cap	cm ³	in ³
620-41081-7	1	steel, galvanized	brass	brass		2,20	0.13
620-41124-1	1	steel, galvanized	brass	plastic		2,20	0.13
620-41081-4	2	steel, galvanized	brass	brass		2,20	0.13
620-41124-2	2	steel, galvanized	brass	plastic		2,20	0.13
620-41124-3	3	steel, galvanized	brass	plastic		2,20	0.13
620-41081-8	3	steel, galvanized	brass	brass		2,20	0.13
620-41081-5	4	steel, galvanized	brass	brass		2,20	0.13
620-41124-4	4	steel, galvanized	brass	plastic		2,20	0.13
620-41081-6	6	steel, galvanized	brass	brass		2,20	0.13
620-41124-6	6	steel, galvanized	brass	plastic		2,20	0.13
620-41081-1	8	steel, galvanized	brass	brass		2,20	0.13
620-41133-1	1	stainless steel, 1.4571	stainless steel, 1.4571	stainless steel, 1.4571		2,20	0.13
620-41133-9	2	stainless steel, 1.4571	stainless steel, 1.4571	stainless steel, 1.4571		2,20	0.13
620-41133-3	3	stainless steel, 1.4571	stainless steel, 1.4571	stainless steel, 1.4571		2,20	0.13
620-41133-5	4	stainless steel, 1.4571	stainless steel, 1.4571	stainless steel, 1.4571		2,20	0.13
620-41133-7	6	stainless steel, 1.4571	stainless steel, 1.4571	stainless steel, 1.4571		2,20	0.13
620-41124-7	7	steel, galvanized	brass	plastic		2,20	0.13
620-41081-2	7	steel, galvanized	brass	brass		2,20	0.13
620-41124-8	8	steel, galvanized	brass	plastic		2,20	0.13
620-41081-1	8	steel, galvanized	brass	brass		2,20	0.13

Accessories

Welding plates for VSG and VSL

Order number	Model
432-21791-1	VSG2/VSL2
432-21792-1	VSG4/VSL4
432-21793-1	VSG6/VSL6
432-21794-1	VSG8/VSL8

Extensions for VSG and VSL

Order number	Model
420-23872-1	VSG, 1.4305
420-22139-1	VSG
420-24832-1	VSL
420-22140-1	VSL

Metering screw for VSG

Order number	Output		Material
	cm ³	in ³	
303-17505-1	0,55	0.33	steel
303-17506-1	1,10	0.67	steel
303-17507-1	1,65	0.10	steel
303-17508-1	2,2	0.13	steel
303-16283-1	0,55	0.33	stainless steel 1.4305/303
303-16198-1	1,10	0.67	stainless steel 1.4305/303
303-16760-1	1,65	0.10	stainless steel 1.4305/303
303-19759-1	2,2	0.13	stainless steel 1.4305/303
303-16696-1	0,55	0.33	stainless steel 1.4571/316Ti
303-16695-1	1,10	0.67	stainless steel 1.4571/316Ti
303-16694-1	1,65	0.10	stainless steel 1.4571/316Ti
303-16224-1	2,2	0.13	stainless steel 1.4571/316Ti

Magnetic indicator for VSG

Order number	Metering quantity		Protection cap material
	cm ³	in ³	
520-33105-1	0,55	0.033	brass
520-33106-1	1,10	0.043	brass
520-33107-1	1,65	0.065	brass
520-33073-1	2,20	0.087	brass
520-33270-1	0,55	0.033	plastic
520-33271-1	1,10	0.043	plastic
520-33272-1	1,65	0.065	plastic
520-33273-1	2,20	0.087	plastic

Metering device

VSL

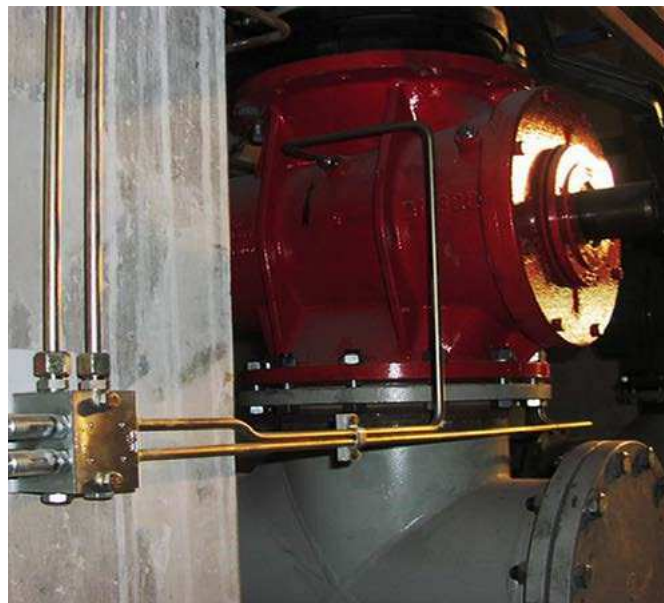

Description

The durable, galvanized steel VSL metering devices are designed for dual-line systems with pressures of up to 400 bar (5 800 psi). These metering devices are available with up to eight outlets, and each pair of outlets is equipped with an indicator pin for visual monitoring. Also, the VSL metering devices are available with low-wear proximity switches, or piston detectors, for electrical monitoring. Additional features include rust-resitant material.

Features and benefits

- Easy cross-porting with external screw to combine
- Solid-block construction for durability and error-free exchange
- Operates effectively in a wide range of temperatures
- Easy to monitor

Applications

- Steel plants
- Cement plants
- Mining excavators

Technical data

Function principle	metering devices
Outlets	2-8
Operating temperature	KR, KA, KD, D: max. +80 °C, +176 °F MD, KR-FKM: max. +120 °C, +248 °F
Lubricant	grease up to NLGI 3 oil with a viscosity of min 20 mm ² /s
Operating pressure	max. 400 bar, 5 800 psi
Materials	steel galvanized or stainless steel 1.4305/303 on request
Metering quantity per stroke	0-5 cm ³ , 0-0.3 in ³ or fixed output: 1.25; 2.5; 3.75; 5 cm ³ , 0.076; 0.15; 0.23; 0.31 in ³ , order number on request
Main line connection inlet	G 3/8, 3/8 NPTF
Outlet connection	G 1/4, 1/4 NPTF
Dimensions	min. 148 × 94 × 54 mm max. 148 × 220 × 54 mm min. 5.83 × 3.70 × 2.13 in max. 5.83 × 8.66 × 2.13 in

NOTE

Further technical information, technical drawings, accessories, spare parts or product function descriptions are available on SKF.com/lubrication.

3D

skf-lubrication.partcommunity.com/3d-cad-models

Metering device

VSL

VSL carbon steel galvanized

Order number BSPP	NPTF	Outlets	Material Steel galvanized	Indication and monitoring Indicator pin adjustable output KR FKM U-cup seal	Piston detector NP	Adapter for limit switch KA ¹⁾	Limit switch KS
620-40062-1	620-40062-2	1	•	•	–	–	–
620-40062-3	620-40062-4	2	•	•	–	–	–
620-40062-5	620-40062-6	3	•	•	–	–	–
620-40062-7	620-40062-8	4	•	•	–	–	–
620-40064-1	620-40064-2	5	•	•	–	–	–
620-40064-3	620-40064-4	6	•	•	–	–	–
620-40064-5	620-40064-6	7	•	•	–	–	–
620-40064-7	620-40064-8	8	•	•	–	–	–
620-40527-1	–	1	•	•	•	–	–
620-40526-1	620-40937-2	2	•	•	•	–	–
620-40526-9	–	3	•	•	•	–	–
620-40526-4	620-40937-4	4	•	•	•	–	–
620-40526-5	–	5	•	•	•	–	–
620-40526-6	620-40937-6	6	•	•	•	–	–
620-40526-7	–	7	•	•	•	–	–
620-40526-8	620-40937-8	8	•	•	•	–	–
620-40853-1	–	1	•	•	–	•	–
620-40853-2	–	2	•	•	–	•	–
620-40853-3	–	3	•	•	–	•	–
620-40853-4	–	4	•	•	–	•	–
620-40853-6	–	6	•	•	–	•	–
620-40853-8	–	8	•	•	–	•	–
620-40637-2	–	2	•	•	–	•	–
620-40637-4	–	4	•	•	–	•	–
620-40637-6	–	6	•	•	–	•	–
620-40637-8	–	8	•	•	–	•	–
620-40068-1	620-40068-2	1	•	•	–	–	•
620-40068-3	620-40068-4	2	•	•	–	–	•
620-40068-5	620-40068-6	3	•	•	–	–	•
620-40068-7	620-40068-8	4	•	•	–	–	•
620-40069-1	620-40069-2	5	•	•	–	–	•
620-40069-3	620-40069-4	6	•	•	–	–	•
620-40069-5	620-40069-6	7	•	•	–	–	•
620-40069-7	620-40069-8	8	•	•	–	–	•

¹⁾ thread M12x1

VSL

Order number BSPP	NPTF	Outlets	Material Carbon steel galvanized	Indication and monitoring Indicator pin; fixed output; metering screw KD ¹⁾	Metering screw D ¹⁾
620-40065-1	620-40065-2	1	•	•	–
620-40065-3	620-40065-4	2	•	•	–
620-40065-5	620-40065-6	3	•	•	–
620-40065-7	620-40066-8	4	•	•	–
620-40066-1	620-40066-2	5	•	•	–
620-40066-3	620-40066-4	6	•	•	–
620-40066-5	620-40066-6	7	•	•	–
620-40066-7	620-40066-8	8	•	•	–
620-40063-1	620-40063-2	1	•	–	•
620-40063-3	620-40063-4	2	•	–	•
620-40063-5	620-40063-6	3	•	–	•
620-40063-7	620-40063-8	4	•	–	•
620-40067-1	620-40067-2	5	•	–	•
620-40067-3	620-40067-4	6	•	–	•
620-40067-5	620-40067-6	7	•	–	•
620-40067-7	620-40067-8	8	•	–	•

¹⁾ also available: 1,25; 2,5; 3,75 cm³, 0,07, 0,15, 0,228 in³

Metering device

VSL

VSL-MD.. , with connection thread BSPP

Order number	Outlets	Material				Metering quantity max.	
			Metering device	Regulating sleeve	Protection cap	cm ³	in ³
620-41125-1	1	steel, galvanized			plastic	5,00	0.30
620-41079-6	1	steel, galvanized	brass		brass	5,00	0.30
620-41079-2	2	steel, galvanized	brass		brass	5,00	0.30
620-41125-2	2	steel, galvanized	brass		plastic	5,00	0.30
620-41125-3	3	steel, galvanized	brass		plastic	5,00	0.30
620-41079-7	3	steel, galvanized	brass		brass	5,00	0.30
620-41079-4	4	steel, galvanized	brass		brass	5,00	0.30
620-41125-4	4	steel, galvanized	brass		plastic	5,00	0.30
620-41125-5	5	steel, galvanized	brass		plastic	5,00	0.30
620-41079-8	5	steel, galvanized	brass		brass	5,00	0.30
620-41079-5	6	steel, galvanized	brass		brass	5,00	0.30
620-41125-6	6	steel, galvanized	brass		plastic	5,00	0.30
620-41125-7	7	steel, galvanized	brass		plastic	5,00	0.30
620-41079-9	7	steel, galvanized	brass		brass	5,00	0.30
620-41079-3	8	steel, galvanized	brass		brass	5,00	0.30
620-41125-8	8	steel, galvanized	brass		plastic	5,00	0.30

Metering screw for VSL

Order number	Metering quantity		Material
	cm ³	in ³	
303-17509-1	1,25	0.49	steel
303-17510-1	2,50	0.98	steel
303-17511-1	3,75	1.48	steel
303-17512-1	5,00	1.97	steel
303-16106-1	2,50	0.98	stainless steel 1.4305/303
303-19809-1	3,75	1.48	stainless steel 1.4305/303
303-19760-1	5,00	1.97	stainless steel 1.4305/303

Extensions for VSL

Order number	Model
420-24832-1	VSL
420-22140-1	VSL

VSL

223-13052-1



Check valve

Order number	Tube	Designation
	Ø mm	
223-13052-1	6	GERV 6-S G 1/4 AVCF
223-13052-2	8	GERV 8-L G 1/4 AVCF
223-13052-3	10	GERV 10-L G 1/4 AVCF

VSG4-KR with welding plate and extension



Welding plate for VSG and VSL

Order number	Model
432-21791-1	VSG2/VSL2
432-21792-1	VSG4/VSL4
432-21793-1	VSG6/VSL6
432-21794-1	VSG8/VSL8

520-33277-1



Magnetic indicator for VSL

Order number	Metering quantity		Protection cap material
	cm ³	in ³	
520-33103-1	1,25	0.49	brass
520-33104-1	2,50	0.98	brass
520-33108-1	3,75	1.48	brass
520-33074-1	5,00	1.97	brass
520-33274-1	1,25	0.49	plastic
520-33275-1	2,50	0.98	plastic
520-33276-1	3,75	1.48	plastic
520-33277-1	5,00	1.97	plastic

Metering device

SGA/SG



Description

Designed for use in dual-line lubrication systems, SGA and SG metering devices feature a modular design with separate base plate that makes system modification simple. Made of zinc-coated carbon steel or stainless steel, these metering devices are installed on aluminium or stainless steel BPSG base plates. Available in six basic sizes, the SGA and SG metering devices meet industrial needs ranging from small joints to large roller bearings.

Features and benefits

- Versatile and durable
- Modular units provide easy system modification and maintenance without costly piping work
- Manufactured from zinc-coated carbon steel or stainless steel AISI-316 L to resist corrosion
- Suitable for lubricants up to NLGI 2

Applications

- Paper industry
- Steel Industry
- Heavy industry

Technical data

Function principle	metering devices
Outlets	1-12
Operating temperature	-25 to +80 °C, -13 to +176 °F
Lubricant	oil and greases NLGI 000-2
Operating pressure	SGA 01: max. 250 bar, 3 625 psi SG/SGA 1-5: max. 300 bar, 4 350 psi
Material	carbon steel galvanized or stainless steel
Metering quantity per stroke	0,15-177 cm ³ , 0,01-10,8 in ³
Outlet connection	BSPF and NPTF
Dimensions	min. 73 × 30 × 30 mm max. 307 × 62 × 60 mm min. 2.87 × 1.18 × 1.18 in max. 12.08 × 2.44 × 2.36 in



NOTE

Further technical information, technical drawings, accessories, spare parts or product function descriptions are available on SKF.com/lubrication:

PUB LS/P8 11277 EN

Metering device

SGA/SG

Order information

Order number	Designation	Output per outlet		Outlets	Material		
		cm ³ /stroke	in ³ /stroke		Carbon steel galvanized	Stainless steel	Without mechanical indicator
12387460	SGA-011-ZN	0,30–1,45	0.02–0.09	1	•	–	–
12387560	SGA-11-ZN	0,50–2,55	0.03–0.16	1	•	–	–
12387660	SGA-21-ZN	1,50–8,75	0.09–0.53	1	•	–	–
12388110	SG-31-ZN 1)	8,50–56,0	0.52–3.42	1	•	–	–
12387510	SGA-012-ZN	0,15–0,70	0.01–0.04	2	•	–	–
12387610	SGA-12-ZN	0,25–1,25	0.02–0.08	2	•	–	–
12387710	SGA-22-ZN	0,70–4,35	0.04–0.27	2	•	–	–
12388160	SG-32-ZN 1)	4,30–28,00	0.26–1.71	2	•	–	–
12386560	SGA-011-SS	0,30–1,45	0.02–0.09	1	–	•	–
12386660	SGA-11-SS	0,50–2,55	0.03–0.16	1	–	•	–
12386760	SGA-21-SS	1,50–8,75	0.09–0.53	1	–	•	–
12386610	SGA-012-SS	0,15–0,70	0.01–0.04	2	–	•	–
12386710	SGA-12-SS	0,25–1,25	0.02–0.08	2	–	•	–
12386810	SGA-22-SS	0,70–4,35	0.04–0.27	2	–	•	–
12387160	SG-31-SS 1)	8,5–56,0	0.297–1.941	1	–	•	–
12387260	SG-41-SS 1)	10,96–52,57	0.668–3.208	1	–	•	–
12387360	SG-51-SS 1)	48,03–100,45	2.930–6.129	1	–	•	–
12387210	SG-32-SS 1)	4,88–31,81	0.297–1.941	2	–	•	–
12387310	SG-42-SS 1)	10,96–52,57	0.668–3.208	2	–	•	–
12387410	SG-52-SS 1)	48,03–100,45	2.930–6.129	2	–	•	–
12387470	SGA-011-ZN-WI 2) 3)	0,17–0,79	0.010–0.048	1	•	–	–
12387570	SGA-11-ZN-WI 2) 3)	0,28–1,42	0.017–0.086	1	•	–	–
12387670	SGA-21-ZN-WI 2) 3)	0,80–4,94	0.048–0.301	1	•	–	–
12387520	SGA-012-ZN-WI 2) 3)	0,17–0,79	0.010–0.048	2	•	–	–
12387620	SGA-12-ZN-WI 2) 3)	0,28–1,42	0.017–0.086	2	•	–	–
12387720	SGA-22-ZN-WI 2) 3)	0,80–4,94	0.048–0.301	2	•	–	–
12387525	SGA-011-ZN-NI 3)	0,17–0,79	0.010–0.048	1	•	–	•
12387625	SGA-11-ZN-NI 3)	0,28–1,42	0.017–0.086	1	•	–	•
12387680	SGA-21-ZN-NI 3)	0,80–4,94	0.048–0.301	1	•	–	•
12387530	SGA-012-ZN-NI 3)	0,17–0,79	0.010–0.048	2	•	–	•
12387630	SGA-12-ZN-NI 3)	0,28–1,42	0.017–0.086	2	•	–	•
12387685	SGA-22-ZN-NI 3)	0,80–4,94	0.048–0.301	2	•	–	•

1) That design requires two places on base plate.

2) In WI models there is a metal indicator pin on indicator end (pin moves out and in).

3) In both WI and NI models there is included 3 different size of metering screws.

SGA/SG

BSPG Base plates



BSPG Base plates

Order number	Designation	Connections		Material	
		inlet	outlet	anodized aluminium	stainless steel
12383250	BPSG-01-AL	BSPP 1/4	BSPP 1/8	•	–
12383300	BPSG-02-AL	BSPP 1/4	BSPP 1/8	•	–
12383350	BPSG-03-AL	BSPP 1/4	BSPP 1/8	•	–
12383400	BPSG-04-AL	BSPP 1/4	BSPP 1/8	•	–
12383450	BPSG-05-AL	BSPP 1/4	BSPP 1/8	•	–
12383500	BPSG-06-AL	BSPP 1/4	BSPP 1/8	•	–
12384300	BPSG-01-SS	BSPP 1/4	BSPP 1/8	–	•
12384350	BPSG-02-SS	BSPP 1/4	BSPP 1/8	–	•
12384400	BPSG-03-SS	BSPP 1/4	BSPP 1/8	–	•
12384450	BPSG-04-SS	BSPP 1/4	BSPP 1/8	–	•
12384500	BPSG-05-SS	BSPP 1/4	BSPP 1/8	–	•
12384550	BPSG-06-SS	BSPP 1/4	BSPP 1/8	–	•
12384600	BPSG-01-SS-U	NPTF 1/4	NPTF 1/8	–	•
12384650	BPSG-02-SS-U	NPTF 1/4	NPTF 1/8	–	•
12384700	BPSG-03-SS-U	NPTF 1/4	NPTF 1/8	–	•
12384750	BPSG-04-SS-U	NPTF 1/4	NPTF 1/8	–	•
12384800	BPSG-05-SS-U	NPTF 1/4	NPTF 1/8	–	•
12384850	BPSG-06-SS-U	NPTF 1/4	NPTF 1/8	–	•
12386350	SGA-0-AL	BSPP 1/4	BSPP 1/8	•	–
12386400	SGA-0-SS	BSPP 1/4	BSPP 1/8	–	•

SGA/SG



Doser monitor

Order number	Designation
12388184	Doser monitor SGA-2
12388188	Doser monitor SG-3-4-5
12388192	Doser monitor junction box
12771677	Doser monitor extension cable M 12, l= 1 m
12771678	Doser monitor extension cable M 12, l= 5 m

Description

Designed for use with SGA and SG metering devices in dual-line lubrication systems, this monitor senses the movement of the metering device piston. The doser monitor comes complete with electrical sensors, connection cable and a junction box.

Features and benefits

- Increases metering device operation monitoring level when dosage piston movement is monitored; sensor has no contact with lubricant because of sensor adapter.
- Sensor is easy to install and maintain with separate sensor adapter
- Status of monitor can be confirmed visually by LED signals
- Compatible with all SGA and SG metering devices
- IP 67 protection rating

Applications

- Heavy industry

Technical data

Function principle	monitoring devices
Operating temperature	-20 to +70 °C, -4 to +160 °F
Operating pressure	0-250 bar, 0-3 600 psi
Supply voltage	24 (20-28) V DC
Output signal	potential-free relay contact
Connection	M 12
Protection class	IP 67
Dimensions	68 x 30 x 20 mm 2.67 x 1.18 x 0.78 in



NOTE

Further technical information, technical drawings, accessories, spare parts or product function descriptions are available on SKF.com/lubrication:

PUB LS/P8 11277 EN



Overview of valves

Change-over valves

Product	Function principle	Operation pressure max.		Supply voltage		Page
		bar	<i>psi</i>	V DC	V AC	
DU 1	Pressure operated change-over valve	350	5 075	–	–	52
MP 2	Pneumatically operated change-over valve	400	5 800	24, 110	110, 230	53
E-VALV	Electrically operated change-over valve	300	4351	24	–	54
Maxilube	Electro-pneumatically operated change-over valve	300	4 350	24	115, 230	56
EMU 3	Electrically operated change-over valve	400	5 800	24	230	58

Way valves

Product	Function principle	Operation pressure max.		Supply voltage		Page
		bar	<i>psi</i>	V DC	V AC	
CLV-2	Electro-pneumatically operated shut-off (way) valve	300	4351	24	115, 230	60
E-VALV-S	Electrically operated shut-off (way) valve	300	4351	24	110, 230	62
WSE	Electrically operated shut-off (way) valve	400	5 800	24	230	64

Valve assemblies

Product	Function principle	Operation pressure max.		Supply voltage	Page
		bar	<i>psi</i>	V DC	
DVA	valve assembly	300	4351	24	63

Change-over valve

DU 1



Description

DU 1 are hydraulic change-over valves designed primarily for use in dual-line lubrication systems. These change-over valves alternately discharge lubricant, fed by the pump into one of the two main lines. The other line is connected to the return line connection of the pump. The switching pressure is adjustable.

Features and benefits

- Reliable, even for hard grease
- Change-over process initiated automatically once preset pressure is reached
- Maximum operating pressure of 350 bar (5 076 psi)
- Various mounting positions
- Works effectively in temperatures ranging from -20 to $+80$ °C (-4 to $+176$ °F)

Applications

- Ideal for small, electrically driven dual-line systems that requires minimal monitoring

Technical data

Function principle	change-over valve, hydraulic, pressure operated 4/2 way valves
Operating temperature	-20 to $+80$ °C -4 to $+176$ °F
Lubricant	grease up to NLGI 3, oil with a viscosity of min 20 mm ² /s 14 dm ³ /h, 3.7 gal/h
Flow rate	max. 350 bar, 5 075 psi
Operating pressure	min. 140 bar, max. 350 bar, min. 2 030 psi, max. 5 075 psi
Change-over pressure	G 1/2 female BSPP
Main line connection	
Electrical connection	max. 500 V, 25–60 Hz
Protection class	IP 67
Dimensions	depending on the model min. 195 × 190 × 100 mm max. 195 × 195 × 195 mm min. 7.8 × 7.8 × 4.0 in max. 7.8 × 7.8 × 7.8 in
Mounting position	any

DU 1 Change-over valves mounted on a base plate

Order number	Designation	Description
617-28683-1	DU1-G	
617-28619-1	DU1-GK	with indicator pin
617-36148-9	DU1-GKN	with proximity switch
617-28620-1	DU1-GKS	with indicator pin and limit switch



NOTE

Further technical information, technical drawings, accessories, spare parts or product function descriptions are available on SKF.com/lubrication.



3D

skf-lubrication.partcommunity.com/3d-cad-models

Change-over valve

MP 2



Description

Designed for use in dual-line systems, the pneumatically operated MP 2 change-over valve works like a 4/2-way valve. It alternately discharges the lubricant fed by the pump into one of the main lines while the other main line is connected to the pump's return line connection.

Features and benefits

- Available in four voltages – 24 and 110 V DC, 110 and 220 V AC
- Can be used as a 3/2-way valve for grease systems
- Maximum operating pressure of 400 bar (5 800 psi)
- Works effectively in temperatures ranging from -20 to $+70$ °C (-4 °F to $+158$ °F)

Applications

- Particularly suitable in connection with pneumatically operated pumps like PowerMaster or Lubrigun
- Bottle filling machines in food and beverage plants
- For small, medium and large dual-line systems

Technical data

Function principle	change-over valve, hydraulic, pressure operated 4/2 way valves
Operating temperature	-20 to $+70$ °C -4 to $+158$ °F
Lubricant	grease up to NLGI 3, oil with a viscosity of min 20 mm ² /s
Flow rate	65 dm ³ /h, 17 gal/h
Operating pressure	max. 400 bar, 5 800 psi
Compressed air pressure	max. 10 bar, max. 145 psi
Operating hydraulic pressure	max. 69 bar, max. 870 psi
Main line connection	G 3/4 female BSPP
Voltage	24 or 110 V DC, 110 or 220 V AC
Protection class	IP 65
Dimensions	135 × 400 × 180 mm 5.4 × 16 × 7.2 in
Mounting position	any

MP 2 Change-over valves

Order number	Designation	Voltage
618-28965-2	MP 2-24 V DC	24 V DC
618-28963-1	MP 2-110 V DC	110 V DC
618-28964-2	MP 2-110 V AC	110 V AC
618-28966-2	MP 2-220 V AC	220 V AC

NOTE

Further technical information, technical drawings, accessories, spare parts or product function descriptions are available on SKF.com/lubrication.

Change-over valve

E-VALV



Description

The electrically operated line valve E-VALV is a modular 3/2 valve in which each module has an internal pressure and tank connection. The benefit of the modular structure is that it enables the longest possible pressure discharge time for each lubrication line in a single- or dual-line system. Several lines or channels can be installed with the same valve assembly.

Features and benefits

- Cost efficient electrically operated change-over valve
- Compact and modular design (easy reduce- or extendable)
- System performance optimizing because it enables long pressure discharge time for each lubrication line

Applications

- General industry
- Mining industry
- Steel industry
- Food and beverage
- Cement industry

Technical data

Function principle	electrically operated change-over valve
Operating temperature	-10 to +50 °C 14 to +122 °F
Lubricant	grease up to NLGI 2
Operating pressure	max. 300 bar max. 4 351 psi
Available designs	2, 4, 6, 8, 10, 12, 14 valves (for dual line)
Inlet and outlet connection	12 mm or 1/2 inch pipe connection
Supply voltage	24 V DC
Protection class	IP 67
Dimensions	59 × 100 × 230 mm 2.32 × 3.93 × 9.05 in
Mounting position	any



NOTE

Further technical information, technical drawings, accessories, spare parts or product function descriptions are available on SKF.com/lubrication.

OEVL2BEN

Change-over valve

E-VALV

Order information

Order number ¹⁾	Designation	Number of valves	Description	Lubricant line	Voltage
				Ø	24 V DC
12375470	E-VALV-L2-24	2	Change-over valve L2	12 mm	•
12375475	E-VALV-L2-24-U	2	Change-over valve L2 (US)	1/2 in	•
12375490	E-VALV-L4-24	4	Change-over valve L4	12 mm	•
12375495	E-VALV-L4-24-U	4	Change-over valve L4 (US)	1/2 in	•

¹⁾ Further designs available on request.

Change-over valve

Maxilube



Description

Maxilube change-over valve is an essential part of heavy industry dual-line systems. It has proven its reliability in various applications throughout Pulp & Paper, Steel and Mining industries over past decades. The Maxilube is a compact solution including the main feature as change-over valve but also often with integrated IF-105 control feature. The Maxilube is an air-operated change-over valve unit and it is a vital part of dual-line pumping centre together with a barrel pump (MPB, etc.) package and a pressure air regulator. But even if it is often used in dual line systems it can also be used in single line and progressive systems. There are multiple control options for Maxilube unit such as the integrated control unit IF-105, an external control unit like ST-2240-LUB or control by customer's DCS. There is also an option to monitor Maxilube unit with an external control box which utilizes SMS technology.

Features and benefits

- Reliable, trouble-free operation
- Suitable for lubricants up to NLGI 2
- Available with integrated control IF-105
- Compact and rugged heavy duty design
- Includes control features for spray applications

Applications

- Heavy industry
- Pulp and paper industry
- Mining and steel industry

Technical data

Function principle	change-over valve, electro-pneumatically operated
Operating temperature	0 to +50 °C, +32 to +122 °F
Operating pressure	max. 300 bar, 4 350 psi
Pressure air supply	2,0 to 4,5 bar, 29 to 65 psi
Air flow	max. 300 l/min
Lubricant	grease: up to NLGI 2 oil: 5 000 mm ² /s
Electrical connections	control voltage: 24 V DC power supply: 115/230 V AC 50/60 Hz
Protection class	IP 65
Dimensions	depending on the model min. 650 × 130 × 130 mm max. 1 020 × 130 × 130 mm min. 25.6 × 5.12 × 5.12 in max. 40.16 × 5.12 × 5.12 in
Mounting position	vertical



NOTE

Further technical information, technical drawings, accessories, spare parts or product function descriptions are available on SKF.com/lubrication:

PUB 06414/2 EN

Change-over valve

Maxilube

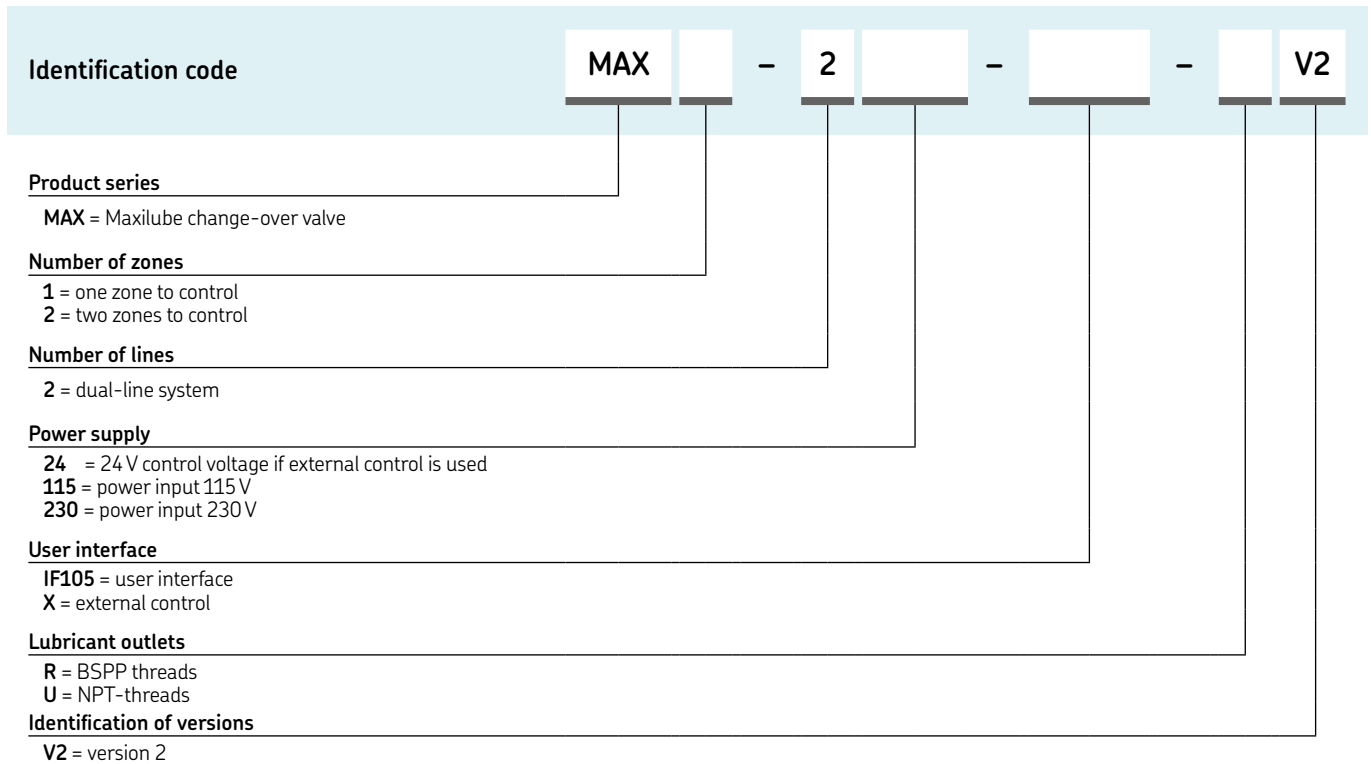

Optional

Maxilube SMS monitoring and control unit



Description

SKF control centres can be equipped with a SMS connection. By using this connection the Maxilube pumping unit and control centres can be controlled by SMS messages. The connection is created between a GSM modem installed in the pumping or control centre and a GSM mobile phone.

SMS unit

Order number	Designation	Description
12380748	E-SMS-C-4G	Maxilube SMS remote control extension

Change-over valve

EMU 3



Description

The electrically operated EMU 3 change-over valve is designed for use with dual-line systems. It is particularly suitable for extended dual-line systems in combination with pneumatically operated supply pumps with large flow rates.

Features and benefits

- Features mid position with option to relieve both main lines toward the pump reservoir during pause time
- System components are pressurized for shorter time periods and have a longer service life
- Risk of bleeding (soap and oil separation) is reduced
- Large connection thread and line distance allow larger tube diameters up to 30 mm (1 1/4 in)

Applications

- Continuous casting machines in steel industry
- Bottle filling machines in food and beverage plants with a few thousand lubrication points
- Large bucket wheel excavators in mining and basic materials industry



Technical data

Function principle	change-over valve, electrically operated 4/3 way valve
Operating temperature	-25 to +70 °C, -13 to +158 °F
Lubricant	grease up to NLGI 3
Flow rate	max. 400 l/h, 105 gal/h
Operating pressure	max. 400 bar, max. 5 800 psi
Main line connection	G 3/4 BSPP
Electrical connection	bayonet plug DIN 72585
Operating voltage	24 V DC or 230 V AC
Protection class	IP 65
Dimensions	220 x 238 x 180 mm 8.64 x 9.35 x 7.07 in
Mounting position	any

Order information

Order number	Voltage	Hydraulic connection ports
EMU-03-00-0000+924	24 V DC	G 3/4 BSPP
EMU-03-00-0000+1KF	230 V AC	G 3/4 BSPP



NOTE

Further technical information, technical drawings, accessories, spare parts or product function descriptions are available on SKF.com/lubrication:

951-171-001 EN



3D

skf-lubrication.partcommunity.com/3d-cad-models

DVA Dualset valve assembly



Description

With the SKF Lincoln Dualset valve assembly you can easily operate an additional barrel pump next to the main pump. This functionality is valuable when grease consumption is high and automatic barrel change is required. Dualset provides confidence in critical applications providing redundant operation in case of pump failure.

DVA can be used with all type of lubrication systems utilizing an air-operated barrel pump and control center supporting Dualset feature. Besides SKF control centers like ST-1340, ST-1440, ST-1240 or ST-2240, Dualset can be controlled by customer's DCS. Dualset comes with a hose kit for Maxilube / MPB pump with "plug and play" connections.

Features and benefits

- Automatic pump change while barrel empty
- Redundant operation in case of pump failure
- Can be added to many existing pumping stations
- Dualset support included on IF-105, ST-1340, ST-1440, ST-1240 and ST-2240 control units

Applications

- Steel industry
- Pulp and paper industry
- Mining industry

Technical data

Function principle	valve assembly for air-operated barrel pumps
Operating temperature	0 to +50 °C, -32 to +122 °F
Operating pressure	max. 300 bar, max. 4 350 psi
Lubrication line connections	Ø12 mm connectors acc. to DIN2353 / ISO8434-1
Air connection	Ø8 mm push in connectors
Electrical connection	bayonet plug DIN 72585
Operating voltage	24 V DC or 230 V AC
Protection class	IP 65
Dimensions	220 × 238 × 180 mm 8.64 × 9.35 × 7.07 in
Mounting position	any

Order information

Order number	Designation
12386002	DUALSET VALVE ASSEMBLY



NOTE

Further technical information, technical drawings, accessories, spare parts or product function descriptions are available on SKF.com/lubrication:

18528 EN

Shut-off (way) valve

CLV-2



Description

In grease lubrication systems, lubrication channels connected to one pump unit are separated from each other by shut-off (way) valves. CLV-2 air-operated shut-off valve can be controlled by SKF control centre or directly by the machine controls.

Features and benefits

- Very simple and reliable operation
- Low maintenance costs
- Robust design with visual indicator pin

Applications

- Heavy industry
- Pulp and Paper industry
- Steel industry
- Mining industry

Technical data

Function principle	electro-pneumatically operated shut-off (4/2 way) valve
Operating temperature	-10 to +50 °C, 14 to +122 °F
Lubricant	grease up to NLGI 2
Operating pressure	max. 300 bar, max. 4 351 psi
Air pressure	4-7 bar; 58 to 101 psi
Lubrication line connection	G 3/4 BSPP or NPTF
Air connection	G 1/8 BSPP or NPTF
Electrical connection	MPM-712 DIN 43650-A
Supply voltage	24 V DC, 115 V AC or 230 V AC
Protection class	IP 65
Dimensions	230 × 125 × 103 mm 9.05 × 4.92 × 4.05 in
Mounting position	any



NOTE

Further technical information, technical drawings, accessories, spare parts or product function descriptions are available on SKF.com/lubrication.

Shut-off (way) valve

CLV-2

Order information				
Order number	Designation	Voltage		
		24 V DC	115 V AC	230 V AC
12385860	CLV-2-24-NC shut-off valve	•	–	–
12385865	CLV-2-24-NO shut-off valve	•	–	–
12385900	CLV-2-24-NC-U shut-off valve	•	–	–
12385950	CLV-2-24-NO-U shut-off valve	•	–	–
12385880	CLV-2-230-NC shut-off valve	–	–	•
12385885	CLV-2-230-NO shut-off valve	–	–	•
12385550	CLV-2-115-NC-U shut-off valve	–	•	–
12385600	CLV-2-115-NO-U shut-off valve	–	•	–

Shut-off (way) valve

E-VALV-S



Description

The shut-off valve E-VALV-S is either 2/2- or 4/2-way valve and some models are equipped with check valves. E-VALV-S consists of the valve body, an optional thrust valve and a solenoid valve, a coil, and a plug with a maintenance power reducer in 110 and 230 VDC. All E-VALV-S units can be connected directly to machine control (interlocking).

Features and benefits

- Cost efficient electrically driven shut-off valve that requires no pressurized air
- System performance optimizing because it enables long pressure discharge time for each lubrication line

Applications

- General industry
- Mining industry
- Pulp and Paper industry
- Steel industry
- Food and beverage
- Cement industry

Technical data

Function principle	electrically operated shut-off (way) valve
Operating temperature	-10 to +50 °C 14 to +122 °F
Lubricant	grease up to NLGI 2
Operating pressure	max. 300 bar max. 4 351 psi
Inlet and outlet connection	12 mm or 1/2 in pipe connection
Supply voltage	24 V DC, 110 and 230 V AC
Protection class	IP 67
Dimensions	123 × 90 × 200 mm 4.84 × 3.54 × 7.87 in
Mounting position	any



NOTE

Further technical information, technical drawings, accessories, spare parts or product function descriptions are available on SKF.com/lubrication.

Shut-off (way) valve

E-VALV-S

Order information

Order number ¹⁾	Designation	Description	Voltage			
			Lubricant line Ø	24 V DC	110 V AC	230 V AC
12375780	E-VALV-S2-NC-24	Shut-off valve, normally (de-energized) closed	12 mm	•	–	–
12375785	E-VALV-S2-NC-24-U	Shut-off valve, normally (de-energized) closed	1/2 in	•	–	–
12375790	E-VALV-S2-NC-110-U	Shut-off valve, normally (de-energized) closed	1/2 in	–	•	–
12375795	E-VALV-S2-NC-230	Shut-off valve, normally (de-energized) closed	12 mm	–	–	•

¹⁾ Further designs available on request.

Shut-off (way) valve

WSE



Description

The factory-set closing of certain connection ports of the EMU 3 allows its use as a reliable and efficient shut-off or way valve. In this case, the "M" position cannot be used. The designation for these way valves is WSE.

Features and benefits

- Functions reliably under harsh conditions due to an electrically operated piston slide valve
- Provides resistance against solid additives in greases
- Large connection thread and line distance allow larger tube diameters up to 30 mm (1 1/4 in)

Applications

- Continuous casting machines in steel industry
- Bottle-filling machines in food and beverage plants with a few thousand lubrication points
- Large bucket wheel excavators in mining and basic materials industry

Technical data

Function principle	change-over valve, electrically operated 4/3 way valve
Operating temperature	-25 to +70 °C, -13 to +158 °F
Lubricant	grease up to NLGI 3
Flow rate	max. 400 l/h, 105 gal/h
Operating pressure	max. 400 bar, max. 5 800 psi
Main line connection	G 3/4 BSPP
Electrical connection	bayonet plug DIN 72585
Operating voltage	24 V DC or 230 V AC
Protection class	IP 65
Dimensions	220 x 238 x 180 mm 8.64 x 9.35 x 7.07 in
Mounting position	any



NOTE

Further technical information, technical drawings, accessories, spare parts or product function descriptions are available on SKF.com/lubrication:

951-171-001 EN

Shut-off (way) valve

WSE

Order information				
Order number	Designation	Voltage		Hydraulic connection ports
		24 V DC	230 V AC	
EMU-22-66-0000+1KF	WS-E 2/2 way valve	•	–	connection ports B and R closed
EMU-22-66-0000+924	WS-E 2/2 way valve	–	•	connection ports B and R closed
EMU-32-06-0000+1KF	WS-E 3/2 way valve	•	–	connection port R closed
EMU-32-06-0000+924	WS-E 3/2 way valve	–	•	connection port R closed
EMU-32-60-0000+1KF	WS-E 3/2 way valve	•	–	connection port B closed
EMU-32-60-0000+924	WS-E 3/2 way valve	–	•	connection port B closed



Overview of pressure sensors

Mechanical pressure switches

Product	Function principle	Operation pressure max.		Supply voltage		Page
		bar	<i>psi</i>	V DC	V AC	
DSB 1	Mechanical pressure switch	300	4 350	36	30	68

Electric pressure switches/transmitter

Product	Function principle	Operation pressure max.		Supply voltage		Page
		bar	<i>psi</i>	V DC	V AC	
EDW	Electric pressure switch	600	8 700	–	–	70
DW	Electric pressure switch	175/400	2 465/5 800	24	–	71
BPSG PTA-MOD	Electric pressure transmitter for SGA systems	250	3 600	24	–	72
DDS 50/1	Differential pressure switch	400	5 800	24	400/500	73
DPC 1	End-of-line pressure switch unit	400	5 800	24	–	74

Pressure switch

DSB 1



Description

Product series DSB consists of mechanical-piston pressure switches designed for use with NLGI Grade 1–2 greases. The location of the actuating piston inside the pressure switch housing helps to ensure a continuous exchange of grease around the measuring point. This reliably prevents the same grease from being pressurized repeatedly, which could cause lubricant soap and oil separation, also known as grease bleeding. Based on the application, the pressure switch can be configured as a single or double design and with or without a measurement connector or pressure gauge. The pressure switch generally is installed upstream of the last lubricant distributor.

Features and benefits

- Available in pre-adjusted versions ranging from 20 to 300 bar (290 to 4 350 psi)
- Prevents oil separation-related faults
- Reliable micro-switch technology with change-over contact (NO and NC)
- Includes built-in manifold for continuous lubricant flow without dead volume
- IP 65 protection rating, corrosivity category C3 or C5M

Applications

- General industry
- Steel industry
- Wind industry
- Mining industry
- Heavy industry



Technical data

Function principle	mechanical piston pressure switch
Operating temperature	–25 to +80 °C, –13 to +132 °F
Operating pressure	max. 300 bar, 4 350 psi
Lubricant	oil and grease NLGI 1 and 2
Breaking capacity, ohm load	max. 1,2 VA
Supply voltage	max. 30 V AC/36 V DC
Supply current	min. 1 mA, max. 50 mA
Type of contact	change-over
Connection method	clamps
Mechanical service life	10 ⁵ switching cycles
Housing material	aluminium, anodized
Contact material	silver alloy, hard gold plating
Connector socket 3+PE	DIN EN 175 301-803 A
Connection	G 1/4
Dimensions	60 × 76 × 105 mm 2.36 × 3 × 4.13 in
Protection class	IP 65
Mounting position	any
Certification	Germanischer Lloyd (GL) certification



NOTE

Further technical information, technical drawings, accessories, spare parts or product function descriptions are available on SKF.com/lubrication:

1-1701 EN

End-of-line pressure unit

EDW



Description

EDW end-of-line pressure switches are key components in a dual-line lubrication system. Designed to monitor the system, these switches detect the pressure at the end of the respective main line and start the change-over procedure. If the pressure at the end of the line is not reached within a specific period of time, a fault signal will be generated at the electronic control unit.

Features and benefits

- Controls proper functioning of the pump and change-over unit
- Monitors for leaks in the tube line system
- Available with limit switches or with electronic pressure switches with LED display
- Proven, rigid design for tough conditions

Applications

- Large dual-line systems
- Steel mills
- Cement plants
- Minerals and mining

Technical data

Function principle	electronic pressure switch with 4-digit 7-segment LED display
Operating temperature	-25 to +85 °C -13 to +185 °F
Operating pressure	0–600 bar, 0–8 700 psi
Main line connection	G 1/4 male
Electrical connections	4 pin plug, M 12 × 1
Supply voltage	18–36 V DC
Dimensions	150 × 250 × 60 mm 5.9 × 9.9 × 2.4 in
Protection class	IP 67
Mounting position	any

Order information

Order number	Designation
632-36501-1	EDW end-of-line pressure unit with limit switches and pressure gauges
632-36627-3	EDW end-of-line pressure unit with electronic pressure switches with LED display



NOTE

Further technical information, technical drawings, accessories, spare parts or product function descriptions are available on SKF.com/lubrication.

Electric pressure switch

DW



Description

Electric pressure switches are used to monitor the operating pressure of the pump. They are installed at the pressure outlet of the pump and will switch off the pump if an overpressure occurs downstream in the system.

Features and benefits

- Protects the system from damage caused by overpressure
- All parameters can be set by keypad
- Adjustable keypad lock
- Rugged construction, vibration and shock-proof
- Long-term stability

Applications

- Dual-line pumps
- Steel mills
- Cement plants
- Minerals and mining

Technical data

Function principle	electric pressure switch
Operating temperature	-25 to +85 °C, +13 to +185 °F
Operating pressure	0–600 bar; 0–8 700 psi
Input data measuring range	0–600 bar; 0–8 700 psi overload pressure: 750 bar; 10 870 psi burst pressure: 800 bar; 11 600 psi
Output data	accuracy >=0,5% full scale
Analog output	signal 4–20 mA
Switching output	type PNP transistor output switching current max. 0,5 A
Supply voltage	18–36 V DC
Hydraulic connection	G 1/4
Protection class	IP 67
Dimensions	94 x 34 x 49 mm; 3.7 x 1.34 x 1.93 in
Mounting position	any

Order information

Order number	Designation
--------------	-------------

623-37567-1	Electric pressure switch with transducer kit for 40 and 100 l, 10 and 26 gal, reservoir versions, includes electronic pressure and digital display
--------------------	--



NOTE

Further technical information, technical drawings, accessories, spare parts or product function descriptions are available on SKF.com/lubrication.

Pressure transmitter

BPSG PTA-MOD

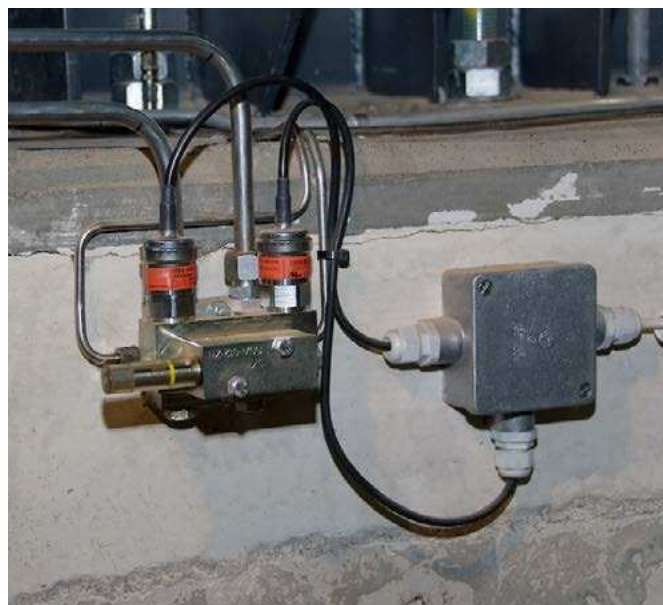

Description

The BPSG2-PTA-MOD pressure transmitter assembly features a modular design for easy installation and service. Located between the base plate and metering device, the assembly's pressure transmitters measure the pressure of passing lubricant and notify the control unit. These end-of-line (main lines) pressures can also be monitored from the lubrication system's control unit.

Features and benefits

- Simple to install; no extra parts required
- Suitable for oils and greases up to NLGI Grade 2
- Helps to ensure that fresh lubricant flows through transmitters; no clogging
- Operates effectively in a wide range of temperatures
- IP 67 protection rating (for models with enclosure)

Applications

- Paper industry
- Steel industry
- Heavy industry

Technical data

Function principle	monitoring device
Operating temperature	-30 to +85 °C, -22 to +185 °F
Operating pressure	0-250 bar, 0-3 600 psi
Materials	metering device: carbon steel galvanized or stainless steel transmitter: stainless steel
Supply voltage	24 (10-30) V DC
Output connection	4...20 mA, 2 wire cable
Protection class	IP 67
Dimensions	110 x 105 x 33 mm 4.33 x 4.13 x 1.29 in
Mounting position	any

Order information

Order number	Designation	Material	
		Carbon steel zinc coated	Stainless steel
12385333	BSPG2-PTA-MOD-D-ZN	•	-
12385331	BSPG2-PTA-MOD-D-SS	-	•

NOTE

Further technical information, technical drawings, accessories, spare parts or product function descriptions are available on SKF.com/lubrication:
PUB LS/P8 11277 EN

Differential pressure switch

DDS 50/1

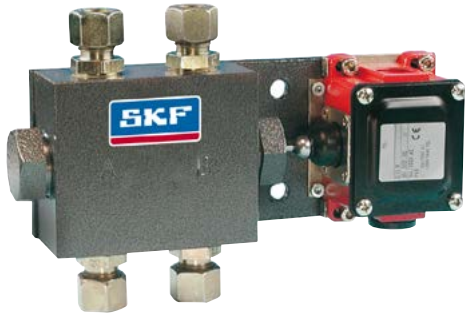

Description

This differential pressure switch measures the difference in pressure between main feed lines 1 and 2. A signal is sent to the electrical control unit when a differential pressure of $p = 50$ bar is reached. This non-adjustable differential pressure provides a high degree of functional reliability for dual-line systems. The DDS 50/1 pressure switch is installed upstream of the lubricant metering device.

Features and benefits

- Provides fixed differential pressure; no regulating screws needed
- Reliable design for harsh environments
- Maintains system pressure on the lowest and most economical pressure level during summer and winter
- Reduces risk of grease bleeding (soap and oil separation)

Applications

- Mining industry
- Steel industry
- Heavy industry

Technical data

Function principle	differential pressure switch
Operating temperature	-25 to $+80$ °C, -13 to $+176$ °F
Operating pressure	max. 400 bar, max. 5 800 psi
Differential pressure	50 bar, 725 psi
Supply voltage	400 V AC
Nominal current	10 A
Used contact	2 closer
Connection method	clamps
Dimensions	min. 215 × 80 × 59 mm max. 221 × 80 × 59 mm min. 8.46 × 3.15 × 2.32 in max. 8.7 × 3.15 × 2.32 in
Protection class	IP 65
Mounting position	any

Order information

Order number	Designation
24-2583-2563	DDS 50/1 (Ui 500 V AC)

NOTE

Further technical information, technical drawings, accessories, spare parts or product function descriptions are available on SKF.com/lubrication.

Dual pressure controller

DPC 1



Description

The DPC1 dual pressure controller was designed for dual-line lubrication systems that use a change-over valve controlled by an end-of-line pressure switch unit. The controller increases the energy efficiency of the system by matching the operating pressure to the ambient conditions. As a result, the pump motor only runs for as long as is required for pressure buildup. In the case of air-operated driven pumps, compressed air is conserved. The DPC 1 controller consists of a housing with integrated control electronics, an LCD and a membrane keypad. For the operation, there are two pressure sensors available, which will be installed in each main line.

Features and benefits

- Monitors proper function of system with regard to pump and change-over valve and detects tube line leaks
- Self-adjusting operating pressure increases service cycle of system components
- Integrated timer enables system operation without separate controller
- Measures the absolute min. and max. in the main lines
- Measures the differential pressure minimum and maximum
- IP 65 protection rating and Shockproof for rigorous environments

Applications

- Paper mills
- Steel mills
- Heavy industry
- Beverage industry



Technical data

Function principle	end-of-line-pressure switch unit
Operating temperature	-25 to 70 °C -13 to +158 °F
Lubricant	oil and grease
Operating or absolute pressure	max. 400 bar, 5 800 psi
Differential pressure	max. 400 bar, 5 800 psi
Monitoring time	1 sec to 99 min 59 sec
Cycle	1 min to 99 hh 59 min
Shock resistance	20 g
Supply voltage	24 V DC, ± 10%
Overload protection	up to 40 V
EMC	DIN EN 61000-6-2 and 61000-6-3
Reverse polarity protection	integrated
Protection class	IP 65
Dimensions without cable glands	100 × 100 × 62 mm 3.9 × 3.9 × 2.4 in
Mounting position	any



NOTE

Further technical information, technical drawings, accessories, spare parts or product function descriptions are available on SKF.com/lubrication:

PUB 13597 EN

Dual pressure controller

DPC 1

Order information

Order number	Designation
234-10723-3 234-10663-7	DPC 1 end-of-line-pressure switch unit pressure sensor (two required for use with DPC 1)

DPC 1 accessories

Order number	Designation
236-10980-3	motor starter 1,0 A (e.g. for pump unit ZPU 02)
236-10980-4	motor starter 1,6 A (e.g. for pump unit ZPU 08)
236-10980-5	motor starter 4,0 A (e.g. for pump unit ZPU 24)

¹⁾ motor starters to operate electrically driven pumps without separate controller



Overview of control units

Product finder								
Product	Function principle	Designation	Supply voltage		Lubrication channels	Temperature		Page
			V DC	V AC		°C	°F	
LMC 2	Electronic controller	Programmable for all kind of lubrication systems: time- or cycle- dependent lubrication, the counter for chain links.	24	230	2	-10 to +70	+14 to +158	78
LMC 301	Lubrication monitor controller	Can handle up to 3 pumps and various types of lubrication systems. Function keys with menu display.	24	90–264 (47–63 Hz)	3	-40 to +70	-40 to +158	79
ST-1240	Lubrication control center	Can operate 1 or 2 channels of single-line, dual-line and progressive lubrication systems. The lubrication channels can be zones, separated by shut-off valves, or complete lubrication systems with separate pumping centers and different lubricants. Configuration can be set in the field by touchscreen display. Pressure switches, pressure transmitters or piston detectors can be used in both channels.	–	93–132, 186–264	2	0 to +50	+32 to +122	80
ST-2240-LUB	Lubrication control center (modular)	This modular control centre can operate 1 to 14 channels of single-line, dual-line and progressive lubrication systems. Configuration can be set in the field by touchscreen display.	–	93–132, 186–264	1–14	0 to +50	+32 to +122	81

Control units

LMC 2



Description

The LMC is a controller for the electronic management and monitoring of lubrication systems. It combines the advantages of a specially developed printed circuit board (PCB) and a PLC in an economical, compact unit. For dual-line systems, it controls the pump unit, change-over valve and end-of-line devices.

Features and benefits

- Integrated, flexible lubrication programmes
- 8 inputs / 5 outputs – suitable for complex lubrication systems
- Time- or cycle-dependent control of lubrication intervals
- Can be interfaced with common field bus systems

Applications

- Lincoln and SKF single-line, dual-line, multi-line and progressive systems
- Railway lubrication and spray lubrication systems
- Food and beverage
- Chain lubrication systems like Cobra and PMA

Technical data

Function principle	electronic controller
Operating temperature	-10 to +70 °C, +14 to +158 °F
Inputs	max. 8 digital inputs
Outputs	4 relay outputs, 1 electronic
Supply voltage	depending on model 230 V AC, 24 V DC
Protection class	IP 54
Mounting position	any
Dimensions	200 × 120 × 90 mm 7.9 × 4.7 × 3.5 in

Order information

Order number	Designation
236-10567-6	LMC2 230 AC (230 V AC)
236-10567-5	LMC2 24 DC (24 V DC)

For use with electric driven 3-phase pump; need to order motor starter separately.

NOTE

Further technical information, technical drawings, accessories, spare parts or product function descriptions are available on SKF.com/lubrication:

PUB 14004 EN

Control units

LMC 301



Description

The LMC 301 is a compact, modularly expandable control and monitoring device. The device is equipped with an LCD display and 6 functional keys for programming, parameter setting and signalization. The user is guided through the setting menu. Additionally, there is a simple-to-use PC software for parameter setting and diagnostics available.

Features and benefits

- Integrated, flexible lubrication programs
- Basic device with 10 digital inputs, of which two can be used analogously, and eight outputs
- Up to seven extension modules can be added, whereby each module has 10 E 8 A just like the basic device
- Three lubrication pumps can be controlled and monitored, each of which provides up to three lubrication circuits
- Single modules are connected by a bus interface

Applications

- Cement industry
- Steel industry
- Mining – stationary and mobile excavators
- Food and beverage

Technical data

Function principle	electronic controller
Operating temperature	VAC: -10 to +50 °C, +14 to +122 °F V DC: -40 to +70 °C, -40 to +158 °F
Inputs	10 count, short-circuit proof, 2 with analog
Outputs	8 count, relay outputs NO-contact 8 A, 2 of which up to 20 A
Supply Voltage	depending on model 90–264 V AC, 24 V DC ±20%
Protection class	IP 65
Mounting position	vertical
Dimensions	270 × 170 × 90 mm 10.7 × 6.7 × 3.5 in

Order information

Order number	Designation
86500	LMC301: 24 V DC, master, incl. LCD display
86501	LMC301: 100–240 V AC, master, incl. LCD display



NOTE

Further technical information, technical drawings, accessories, spare parts or product function descriptions are available on SKF.com/lubrication:
PUB LS/P2 15967/1 EN

Control units

ST-1240



Description

ST-1240 is a control unit for automatic lubrication systems. While ST-1240-GRAPH is a two-channel lubrication control centre, ST-1240-GRAPH-4 supports up to four channels or zones. With ST-1240-GRAPH-RST a stainless steel version completes the range. All variants support any combination of single-line and progressive automatic lubrication systems (ALS). The lubrication channels can be zones, separated by shut-off valves or independent lubrication systems with separate pumping centres (max. 2) and varying lubricants. ST-1240 control centres come with a user-friendly colour touch screen panel that guides the user step-by-step through the application. The controllers support remote control via mobile devices or fieldbus, allowing easier system inspection and trouble shooting.

Features and benefits

- Reliable lubrication system control
- Control of up to 4 independently operating lubrication channels or lubrication systems
- Control of grease spraying systems incl. air pressure monitoring
- Control of low lubricant filling levels
- Control of system pressure deviations
- On-the fly lubricant barrel exchange (Dualset valve support)

Order information

Order number	Designation	Material (cabinet)
12380210	ST-1240 GRAPH	steel, painted RAL 7035
12380200	ST-1240 GRAPH-4	steel, painted RAL 7035
12380218	ST-1240 GRAPH-RST	stainless steel



Technical data

Function principle	control center
Operating temperature	0 to +50 °C, +32 to +122 °F
Lubrication channels	2 and 4 (depending on model)
Supply voltage	93 to 132 V AC, 186 to 264 V AC
Supply voltage frequency	47 to 63 Hz
Supply current	5,4 A/115 V AC, 2,2 A/230 V AC
Control voltage	24 V DC, ± 10%
Overload protection	automatic fuse, 6 A
Cable connection	screw connections for 2,5 mm ² wires
Protection class	IP 65
Interface	5,7" touchscreen display, 320 x 240 pixel, 64k colors
API	RS-422 port for SKF online software
Terminal connections	Screw connections for 2,5 mm ² wires
Alarm outputs	Relay contact 1pcs (potential-free)
Interlock inputs	2pcs (potential free contact)
Dimensions (without cable glands)	380 x 300 x 210 mm
Weight	14.9 x 11.8 x 8.3 in
	10 kg
	22 lbs
Mounting position	upright



NOTE

Further technical information, technical drawings, accessories, spare parts or product function descriptions are available on SKF.com/lubrication:

PUB LS/P8 12404 EN

Control units

ST-2240-LUB



Description

ST-2240-LUB-6 and ST-2240-LUB-14 lubrication control centers are suitable for use in dual-line lubrication systems, as well as single-line and progressive systems. These units have a touchscreen display and are only differentiated by the cabinet size and maximum number of lubrication channels served. The ST-2240-LUB-6 controls up to 6 separate lubrication channels, while ST-2240-LUB-14 controls up to 14 channels, each having independent lubrication parameters and/allows use of different lubricants if required. The lubrication system is adjustable at field site by adding or reducing channel modules, and configuration can be changed in the field by the user. Pressure switches and transmitters or piston detectors can be used in all channels. Also the new lubricant low level ultrasonic sensor is supported.

Features and benefits

- Versatile and durable, automatic pump change (Dualset)
- Modular units provide easy system modification
- Compatible with ultrasonic low level sensor
- Grease spraying control with air monitoring
- Compatible with SKF doser monitor

Technical data

Function principle	control center
Operating temperature	0 to +50 °C, +32 to +122 °F
Lubricant channels	1-14
Supply voltage	115/230 VAC, automatic range selection
Supply voltage frequency	47 to 63 Hz
Control voltage	24 V DC, ± 10 %
Overload protection	automatic fuse, 6 A
Cable connection	screw terminals for 2,5 mm ² wires
Protection class	IP 65
Interface	5.7" TFT touch screen , 320 × 240, 64k colors, ethernet and USB port mobile app for monitoring
Data logging	Log files on USB memory
Fieldbus	ModbusTCP slave, other protocols on request
Alarm Outputs	relays K1 & K2: potential-free change over contact; maximum load 230V/1A; channel modules: potential-free contact; maximum load 50V DC/1A
Dimensions	600 × 600 × 250 mm 23.6 × 23.6 × 9.8 in

Order information

Order number	Designation
12380760	ST-2240-LUB-6 control center
12380765	ST-2240-LUB-14 control center
12501270	CM channel module



NOTE

Further technical information, technical drawings, accessories, spare parts or product function descriptions are available on SKF.com/lubrication:
PUB LS/P2 17950 EN

Index

24-2583-2563	73	420-22140-1.....	41	603-41200-2	11
223-13052-1.....	11	420-22140-1.....	44	617-28619-1.....	52
223-13052-1.....	37	420-23628-1.....	36	617-28620-1.....	52
223-13052-1.....	40	420-23790-1.....	36	617-28683-1.....	52
223-13052-1.....	45	420-23872-1.....	41	617-36148-9.....	52
223-13052-2.....	11	420-24832-1.....	41	618-28963-1.....	53
223-13052-2.....	37	420-24832-1.....	44	618-28964-2.....	53
223-13052-2.....	40	432-21791-1.....	37	618-28965-2.....	53
223-13052-2.....	45	432-21791-1.....	41	618-28966-2.....	53
223-13052-3.....	11	432-21791-1.....	45	620-27418-1.....	35
223-13052-3.....	37	432-21792-1.....	37	620-27419-1.....	35
223-13052-3.....	40	432-21792-1.....	41	620-27420-1.....	35
223-13052-3.....	45	432-21792-1.....	45	620-27421-1.....	35
234-10663-7.....	75	432-21793-1.....	37	620-27422-1.....	35
234-10723-3.....	75	432-21793-1.....	41	620-27423-1.....	35
236-10567-5.....	78	432-21793-1.....	45	620-27424-1.....	35
236-10567-6.....	78	432-21794-1.....	37	620-27425-1.....	35
236-10980-3.....	75	432-21794-1.....	41	620-27438-1.....	35
236-10980-4.....	75	432-21794-1.....	45	620-27439-1.....	35
236-10980-5.....	75	432-23698-1.....	37	620-27440-1.....	35
303-16106-1.....	44	432-23699-1.....	37	620-27441-1.....	35
303-16198-1.....	41	432-23700-1.....	37	620-27442-1.....	35
303-16224-1.....	41	432-23701-1.....	37	620-27443-1.....	35
303-16283-1.....	41	520-33073-1.....	41	620-27444-1.....	35
303-16694-1.....	41	520-33074-1.....	45	620-27445-1.....	35
303-16695-1.....	41	520-33075-1.....	37	620-27488-1.....	35
303-16696-1.....	41	520-33103-1.....	45	620-27489-1.....	35
303-16760-1.....	41	520-33104-1.....	45	620-27490-1.....	35
303-17505-1.....	41	520-33105-1.....	41	620-27491-1.....	35
303-17506-1.....	41	520-33106-1.....	41	620-27492-1.....	35
303-17507-1.....	41	520-33107-1.....	41	620-27493-1.....	35
303-17508-1.....	41	520-33108-1.....	45	620-27494-1.....	35
303-17509-1.....	44	520-33109-1.....	37	620-27495-1.....	35
303-17510-1.....	44	520-33110-1.....	37	620-27496-1.....	35
303-17511-1.....	44	520-33112-1.....	37	620-27497-1.....	35
303-17512-1.....	44	520-33266-1.....	37	620-27498-1.....	35
303-19351-1.....	36	520-33267-1.....	37	620-27499-1.....	35
303-19352-1.....	36	520-33268-1.....	37	620-27500-1.....	35
303-19354-1.....	36	520-33269-1.....	37	620-27501-1.....	35
303-19356-1.....	36	520-33270-1.....	41	620-27502-1.....	35
303-19357-1.....	36	520-33271-1.....	41	620-27503-1.....	35
303-19359-1.....	36	520-33272-1.....	41	620-27766-1.....	35
303-19374-1.....	36	520-33273-1.....	41	620-27767-1.....	35
303-19375-1.....	36	520-33274-1.....	45	620-27768-1.....	35
303-19759-1.....	41	520-33275-1.....	45	620-27769-1.....	35
303-19760-1.....	44	520-33276-1.....	45	620-27770-1.....	35
303-19809-1.....	44	520-33277-1.....	45	620-27771-1.....	35
420-22139-1.....	41	603-41200-1.....	11	620-27772-1.....	35

Index

620-27773-1.....	35	620-40023-8	40	620-40062-8	43
620-27857-1.....	35	620-40024-1	40	620-40063-1	43
620-27858-1	35	620-40024-2	40	620-40063-2	43
620-27859-1	35	620-40024-3	40	620-40063-3	43
620-27860-1	35	620-40024-4	40	620-40063-4	43
620-27861-1.....	35	620-40024-5	40	620-40063-5	43
620-27862-1	35	620-40024-6	40	620-40063-6	43
620-27863-1	35	620-40024-7	40	620-40063-7	43
620-27864-1	35	620-40024-8	40	620-40063-8	43
620-28366-1	35	620-40025-1	40	620-40064-1	43
620-28367-1.....	35	620-40025-2	40	620-40064-2	43
620-28374-1.....	35	620-40025-3	40	620-40064-3	43
620-28376-1.....	35	620-40025-4	40	620-40064-4	43
620-28391-1	35	620-40025-5	40	620-40064-5	43
620-28392-1	35	620-40025-6	40	620-40064-6	43
620-28393-1	35	620-40025-7	40	620-40064-7	43
620-28394-1	35	620-40025-8	40	620-40064-8	43
620-28409-1	35	620-40026-1	40	620-40065-1	43
620-28410-1	35	620-40026-2	40	620-40065-2	43
620-28411-1.....	35	620-40026-3	40	620-40065-3	43
620-28412-1.....	35	620-40026-4	40	620-40065-4	43
620-28413-1.....	35	620-40026-5	40	620-40065-5	43
620-28414-1.....	35	620-40026-6	40	620-40065-6	43
620-28415-1.....	35	620-40026-7	40	620-40065-7	43
620-28416-1.....	35	620-40026-8	40	620-40066-1	43
620-40015-1	39	620-40027-1	40	620-40066-2	43
620-40015-2	39	620-40027-2	40	620-40066-3	43
620-40015-3	39	620-40027-3	40	620-40066-4	43
620-40015-4	39	620-40027-4	40	620-40066-5	43
620-40015-5	39	620-40027-5	40	620-40066-6	43
620-40015-6	39	620-40027-6	40	620-40066-7	43
620-40015-7	39	620-40027-7	40	620-40066-8	43
620-40015-8	39	620-40027-8	40	620-40066-8	43
620-40022-1	39	620-40028-1	40	620-40067-1	43
620-40022-2	39	620-40028-2	40	620-40067-2	43
620-40022-3	39	620-40028-3	40	620-40067-3	43
620-40022-4	39	620-40028-4	40	620-40067-4	43
620-40022-5	39	620-40028-5	40	620-40067-5	43
620-40022-6	39	620-40028-6	40	620-40067-6	43
620-40022-7	39	620-40028-7	40	620-40067-7	43
620-40022-8	39	620-40028-8	40	620-40067-8	43
620-40023-1	40	620-40062-1	43	620-40068-1	43
620-40023-2	40	620-40062-2	43	620-40068-2	43
620-40023-3	40	620-40062-3	43	620-40068-3	43
620-40023-4	40	620-40062-4	43	620-40068-4	43
620-40023-5	40	620-40062-5	43	620-40068-5	43
620-40023-6	40	620-40062-6	43	620-40068-6	43
620-40023-7	40	620-40062-7	43	620-40068-7	43

Index

620-40068-8	43	620-40733-8	40	620-41122-3.....	35
620-40069-1	43	620-40839-1	39	620-41122-4.....	35
620-40069-2	43	620-40839-2	39	620-41123-2.....	36
620-40069-3	43	620-40839-3	39	620-41123-4.....	36
620-40069-4	43	620-40839-4	39	620-41123-6.....	36
620-40069-5	43	620-40839-5	39	620-41123-8.....	36
620-40069-6	43	620-40839-6	39	620-41124-1.....	41
620-40069-7	43	620-40839-7	39	620-41124-2.....	41
620-40069-8	43	620-40839-8	39	620-41124-3.....	41
620-40525-1.....	39	620-40853-1	43	620-41124-4.....	41
620-40525-2	39	620-40853-2	43	620-41124-6.....	41
620-40525-3	39	620-40853-3	43	620-41124-7.....	41
620-40525-4	39	620-40853-4	43	620-41124-8.....	41
620-40525-5	39	620-40853-6	43	620-41125-1.....	44
620-40525-6	39	620-40853-8	43	620-41125-2.....	44
620-40525-7	39	620-40937-2	43	620-41125-3.....	44
620-40525-8	39	620-40937-4	43	620-41125-4.....	44
620-40526-1	43	620-40937-6	43	620-41125-5.....	44
620-40526-4	43	620-40937-8	43	620-41125-6.....	44
620-40526-5	43	620-41079-2.....	44	620-41125-7.....	44
620-40526-6	43	620-41079-3.....	44	620-41125-8.....	44
620-40526-7	43	620-41079-4.....	44	620-41133-1.....	41
620-40526-8	43	620-41079-5.....	44	620-41133-3.....	41
620-40526-9	43	620-41079-6.....	44	620-41133-5.....	41
620-40527-1.....	43	620-41079-7.....	44	620-41133-7.....	41
620-40567-1.....	39	620-41079-8.....	44	620-41133-9.....	41
620-40567-2	39	620-41079-9.....	44	623-37567-1.....	71
620-40567-3	39	620-41081-1.....	41	632-36501-1.....	70
620-40567-4.....	39	620-41081-1.....	41	632-36627-3	70
620-40567-5	39	620-41081-2	41	001709.....	25
620-40567-6	39	620-41081-4.....	41	001709.....	27
620-40567-7.....	39	620-41081-5.....	41	2340-00000083.....	29
620-40567-8	39	620-41081-6	41	2350-00000077.....	29
620-40605-1	40	620-41081-7.....	41	4090-00000011.....	29
620-40605-2	40	620-41081-8	41	5090-00000001.....	29
620-40605-3	40	620-41086-1	35	5090-00000005.....	29
620-40605-4	40	620-41086-2	35	5090-00000011.....	29
620-40637-2	43	620-41086-3	35	5090-00000012.....	29
620-40637-4	43	620-41086-4	35	5090-00000013.....	29
620-40637-6	43	620-41086-5	35	6640-00000046.....	29
620-40637-8	43	620-41086-6	35	6640-00000064.....	29
620-40733-1.....	40	620-41086-7	35	6640-00000065.....	29
620-40733-2	40	620-41089-2	36	82050	24
620-40733-3	40	620-41089-4	36	82054.....	24
620-40733-4.....	40	620-41089-6	36	83286.....	27
620-40733-5	40	620-41089-8	36	84723.....	26
620-40733-6	40	620-41122-1.....	35	84723.....	27
620-40733-7.....	40	620-41122-2.....	35	84785.....	27

Index

84804.....	26	12384450.....	48	12387680.....	47
84827.....	27	12384500.....	48	12387685.....	47
84997.....	26	12384550.....	48	12387710.....	47
86500.....	79	12384600.....	48	12387720.....	47
86501.....	79	12384650.....	48	12388110.....	47
274681.....	25	12384700.....	48	12388160.....	47
11391525.....	33	12384750.....	48	12388184.....	49
11391530.....	33	12384800.....	48	12388188.....	49
11391535.....	33	12384850.....	48	12388192.....	49
12375020.....	21	12385331.....	72	12501270.....	81
12375100.....	21	12385333.....	72	12771677.....	49
12375180.....	21	12385550.....	61	12771678.....	49
12375470.....	55	12385600.....	61	12800350.....	33
12375475.....	55	12385860.....	61	12800360.....	33
12375490.....	55	12385865.....	61	12800370.....	33
12375495.....	55	12385880.....	61	BPH30-3001AB-VAOM.....	28
12375780.....	63	12385885.....	61	BPH30-3001AB-VAOM 1).....	29
12375785.....	63	12385900.....	61	BPH30-3101AB-VAOM.....	28
12375790.....	63	12385950.....	61	BPH30-3101AB-VAOM 1).....	29
12375795.....	63	12386002.....	59	EMU-03-00-0000+1KF.....	58
12380200.....	80	12386350.....	48	EMU-03-00-0000+924.....	58
12380210.....	80	12386400.....	48	EMU-22-66-0000+1KF.....	65
12380218.....	80	12386560.....	47	EMU-22-66-0000+924.....	65
12380748.....	57	12386610.....	47	EMU-32-06-0000+1KF.....	65
12380760.....	81	12386660.....	47	EMU-32-06-0000+924.....	65
12380765.....	81	12386710.....	47	EMU-32-60-0000+1KF.....	65
12381280.....	21	12386760.....	47	EMU-32-60-0000+924.....	65
12381285.....	21	12386810.....	47		
12381290.....	21	12387160.....	47		
12381381.....	23	12387210.....	47		
12381382.....	23	12387260.....	47		
12381383.....	23	12387310.....	47		
12381384.....	23	12387360.....	47		
12381385.....	23	12387410.....	47		
12381386.....	23	12387460.....	47		
12381700.....	23	12387470.....	47		
12381701.....	23	12387510.....	47		
12381702.....	23	12387520.....	47		
12382666.....	23	12387525.....	47		
12383250.....	48	12387530.....	47		
12383300.....	48	12387560.....	47		
12383350.....	48	12387570.....	47		
12383400.....	48	12387610.....	47		
12383450.....	48	12387620.....	47		
12383500.....	48	12387625.....	47		
12384300.....	48	12387630.....	47		
12384350.....	48	12387660.....	47		
12384400.....	48	12387670.....	47		



Important information on product usage

SKF and Lincoln lubrication systems or their components are not approved for use with gases, liquefied gases, pressurized gases in solution and fluids with a vapor pressure exceeding normal atmospheric pressure (1 013 mbar) by more than 0,5 bar at their maximum permissible temperature.



skf.com | skf.com/lubrication

© SKF and LINCOLN are registered trademarks of the SKF Group.

© SKF Group 2023

The contents of this publication are the copyright of the publisher and may not be reproduced (even extracts) unless prior written permission is granted. Every care has been taken to ensure the accuracy of the information contained in this publication but no liability can be accepted for any loss or damage whether direct, indirect or consequential arising out of the use of the information contained herein.

PUB LS/P1 16132 EN · February 2023

Certain image(s) used under license from Shutterstock.com